

NG | STONE
PORCELAIN SLABS

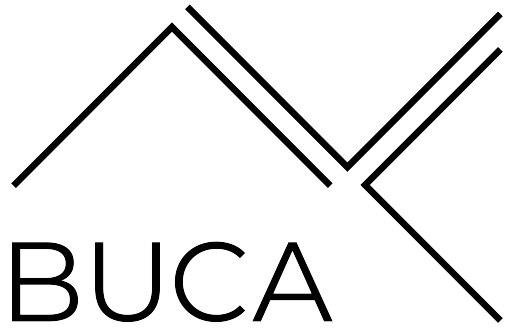

BUCA

Interior Solutions



Dayanıklılığı, estetiği ve inovasyonu yaşamın bir parçası haline getiren NG Stone, kullanıcı dostu özellikleri ile seramiğin sınırlarını aşıyor.

NG Kütahya Seramik'in ustalık eseri olan NG Stone, Türkiye'nin kapalı alanda en büyük granit seramik üretim kapasitesine sahip fabrikalarında hayat buluyor.

160x320 cm ve 80x320 cm ölçülerine, 6 mm ve 12 mm kalınlıklarına sahip, ezberlerin dışında yepyeni bir deneyimle buluşmak isteyenlerin tercihi NG Stone, iç ve dış mekânlar başta olmak üzere tezgah, lavabo, mutfak dolabı ve TV arkası gibi kullanım alanları ile seramiğin standartlarının ötesinde, hayal gücünüzü zorlayacağınız tüm alanlarda kullanma imkanı tanıyor.

Hijyenik yapısı, alternatifli yüzey seçenekleri, geniş kullanım alanları ve sürdürülebilir üretim teknolojisi ile tasarlanan NG Stone; leke ve kimyasallara, termal şoka, neme, UV ışınlarına, çizilmelere ve aşınmalara karşı son derece dayanıklı formuyla seramik sektöründe inovasyonun sınırlarını zorluyor.

Making durability, aesthetics and innovation a part of life, NG Stone transcends the boundaries of ceramics with it's user-friendly features.

NG Stone, the masterpiece of NG Kütahya Seramik, comes to life in the factories with the largest indoor granite ceramic production capacity in Turkey.

NG Stone Porcelain Slabs, which has 160x320 cm and 80x320 cm dimensions, 6 mm and 12 mm thicknesses and is the choice of those who want to meet a brand new experience out of the ordinary, allows you to use it in all areas where you can push your imagination beyond the standards of ceramics with it's usage areas such as countertops, sinks, kitchen cabinets and TV backsplashes, especially indoors and outdoors.

Designed with a hygienic structure, alternative surface options, wide usage areas and sustainable production technology, NG Stone pushes the boundaries of innovation in the ceramic industry with its highly resistant form against stains and chemicals, thermal shock, humidity, UV rays, scratches and abrasions.



TEMİZLEMESİ KOLAY
EASY TO CLEAN



HİJYENİK YÜZEY
HYGIENIC SURFACE



FARKLI YÜZEY SEÇENEĞİ
DIFFERENT SURFACE OPTION



GENİŞ KULLANIM ALANI
WIDE RANGE OF USE



ÇİZİLME ve AŞINMALARA KARŞI DAYANIKLI
RESISTANT TO SCRATCHES AND ABRASIONS

KİMYASALLARA KARŞI DİRENÇLİ
RESISTANT TO CHEMICALS



TERMAL ŞOKA DAYANIKLI
RESISTANT TO THERMAL SHOCK



NEME KARŞI DAYANIKLI
RESISTANT TO MOISTURE



LEKELENMEYE KARŞI DAYANIKLI
RESISTANT TO STAINING



UV IŞINLARINA KARŞI DİRENÇLİ
RESISTANT TO UV RAYS



PORTLAND





PORTLAND



12 MM $\frac{1}{2}$

MAT / MATT

88000048	Mat / Matt	12 mm	163 x 323 cm	Portland Gri Mat 12 mm / Portland Grey Matt 12 mm
88000048R	Mat / Matt	12 mm	160 x 320 cm	Portland Gri Mat 12 mm Rektifiye / Portland Grey Matt 12 mm Rectified



6 MM $\frac{\downarrow}{\uparrow}$

MAT / MATT

88000049	Mat / Matt	6 mm	163 x 323 cm	Portland Gri Mat 6 mm / Portland Grey Matt 6 mm
88000049R	Mat / Matt	6 mm	160 x 320 cm	Portland Gri Mat 6 mm Rektifiye / Portland Grey Matt 6 mm Rectified

PORTLAND



12 MM $\frac{\updownarrow}{\updownarrow}$

MAT / MATT

88000105 | Mat / Matt | 12 mm | 83 x 323 cm | Portland Gri Mat 12 mm / Portland Grey Matt 12 mm

NG | STONE
PORCELAIN SLABS

PORTLAND



12 MM $\frac{\updownarrow}{\updownarrow}$

MAT / MATT

88000046	Mat / Matt	12 mm	163 x 323 cm	Portland FÜme Mat 12 mm / Portland Lead Grey Matt 12 mm
88000046R	Mat / Matt	12 mm	160 x 320 cm	Portland FÜme Mat 12 mm Rektifiye / Portland Lead Grey Matt 12 mm Rectified



6 MM $\frac{\downarrow}{\uparrow}$

MAT / MATT

88000104
88000047R

Mat / Matt
Mat / Matt

6 mm
6 mm

163 x 323 cm
160 x 320 cm

Portland Fume Mat 6 mm / Portland Lead Grey Matt 6 mm
Portland Fume Mat 6 mm Rektifiye / Portland Lead Grey Matt 6 mm Rectified

PORTLAND



12 MM $\frac{\updownarrow}{\updownarrow}$

MAT / MATT

88000104 | Mat / Matt | 12 mm | 83 x 323 cm | Portland Fume Mat 12 mm / Portland Lead Grey Matt 12 mm

NG | STONE
PORCELAIN SLABS

PORTLAND



12 MM $\frac{1}{2}$

MAT / MATT

88000044	Mat / Matt	12 mm	163 x 323 cm	Portland Bej Mat 12 mm / Portland Beige Matt 12 mm
88000044R	Mat / Matt	12 mm	160 x 320 cm	Portland Bej Mat 12 mm Rektifiye / Portland Beige Matt 12 mm Rectified



6 MM $\frac{\downarrow}{\uparrow}$

MAT / MATT

88000045	Mat / Matt	6 mm	163 x 323 cm	Portland Bej Mat 6 mm / Portland Beige Matt 6 mm
88000045R	Mat / Matt	6 mm	160 x 320 cm	Portland Bej Mat 6 mm Rektifiye / Portland Beige Matt 6 mm Rectified

PORTLAND



12 MM $\frac{\updownarrow}{\updownarrow}$

MAT / MATT

88000103 | Mat / Matt | 12 mm | 83 x 323 cm | Portland Bej Mat 12 mm / Portland Beige Matt 12 mm

NG | STONE
PORCELAIN SLABS

VISTA





VISTA



12 MM $\frac{\downarrow}{\uparrow}$

MAT / MATT

88000064	Mat / Matt	12 mm	163 x 323 cm	Vista Gri Mat 12 mm / Vista Grey Matt 12 mm
88000064R	Mat / Matt	12 mm	160 x 320 cm	Vista Gri Mat 12 mm Rektifiye / Vista Grey Matt 12 mm Rectified



6 MM $\frac{\downarrow}{\uparrow}$

MAT / MATT

88000065	Mat / Matt	6 mm	163 x 323 cm	Vista Gri Mat 6 mm / Vista Grey Matt 6 mm
88000065R	Mat / Matt	6 mm	160 x 320 cm	Vista Gri Mat 6 mm Rektifiye / Vista Grey Matt 6 mm Rectified

VISTA

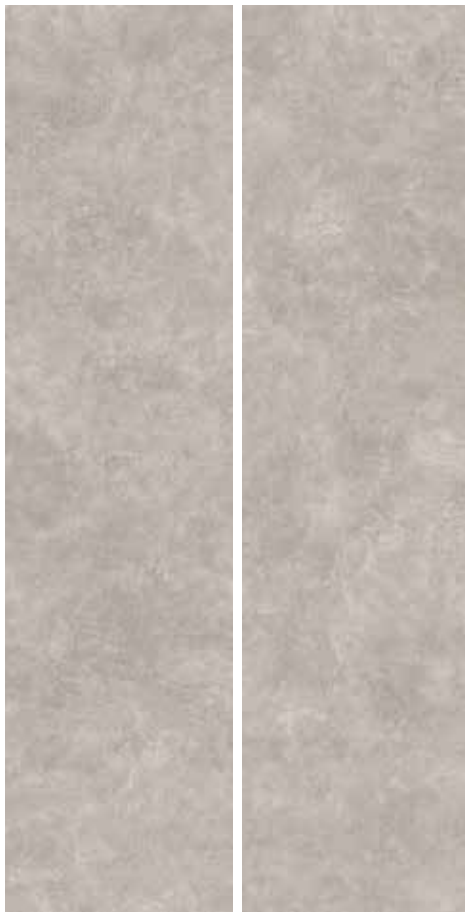

12 MM $\frac{\updownarrow}{\updownarrow}$

MAT / MATT

88000112 | Mat / Matt | 12 mm | 83 x 323 cm | Vista Gri Mat 12 mm / Vista Grey Matt 12 mm

VISTA



12 MM $\frac{\downarrow}{\uparrow}$

MAT / MATT

88000143	Mat / Matt	12 mm	163 x 323 cm	Vista Bone Mat 12 mm / Vista Bone Matt 12 mm
88000143R	Mat / Matt	12 mm	160 x 320 cm	Vista Bone Mat 12 mm Rektifiye / Vista Bone Matt 12 mm Rectified



6 MM $\frac{\downarrow}{\uparrow}$

MAT / MATT

88000190	Mat / Matt	6 mm	163 x 323 cm	Vista Bone Mat 6 mm / Vista Bone Matt 6 mm
88000190R	Mat / Matt	6 mm	160 x 320 cm	Vista Bone Mat 6 mm Rektifiye / Vista Bone Matt 6 mm Rectified

VISTA



12 MM $\frac{\downarrow}{\uparrow}$

MAT / MATT

88000192 | Mat / Matt | 12 mm | 83 x 323 cm | Vista Bone Mat 12 mm / Vista Bone Matt 12 mm

NG | STONE
PORCELAIN SLABS

VISTA



12 MM $\frac{\downarrow}{\uparrow}$

MAT / MATT

88000144	Mat / Matt	12 mm	163 x 323 cm	Vista Fme Mat 12 mm / Vista Lead Grey Matt 12 mm
88000144R	Mat / Matt	12 mm	160 x 320 cm	Vista Fme Mat 12 mm Rektifiye / Vista Lead Grey Matt 12 mm Rectified



6 MM $\frac{\downarrow}{\uparrow}$

MAT / MATT

88000191
88000191R

Mat / Matt
Mat / Matt

6 mm
6 mm

163 x 323 cm
160 x 320 cm

Vista Fume Mat 6 mm / Vista Lead Grey Matt 6 mm
Vista Fume Mat 6 mm Rektifiye / Vista Lead Grey Matt 6 mm Rectified

VISTA



12 MM $\frac{\updownarrow}{\updownarrow}$

MAT / MATT

88000200 | Mat / Matt | 12 mm | 83 x 323 cm | Vista Fume Mat 12 mm / Vista Lead Grey Matt 12 mm

ANATOLIAN BLACK





ANATOLIAN BLACK



12 MM $\frac{1}{2}$

PARLAK / GLOSSY

MAT / MATT

88000010P	Parlak / Glossy	12 mm	163 x 323 cm	Anatolian Black Parlak 12 mm / Anatolian Black Glossy 12 mm
88000010RP	Parlak / Glossy	12 mm	160 x 320 cm	Anatolian Black Parlak 12 mm Rektifiye / Anatolian Black Glossy 12 mm Rectified
88000010	Mat / Matt	12 mm	163 x 323 cm	Anatolian Black Mat 12 mm / Anatolian Black Matt 12 mm
88000010R	Mat / Matt	12 mm	160 x 320 cm	Anatolian Black Mat 12 mm Rektifiye / Anatolian Black Matt 12 mm Rectified



6 MM $\frac{\downarrow}{\uparrow}$

PARLAK / GLOSSY

MAT / MATT

88000011P	Parlak / Glossy	6 mm	163 x 323 cm	Anatolian Black Parlak 6 mm / Anatolian Black Glossy 6 mm
88000011RP	Parlak / Glossy	6 mm	160 x 320 cm	Anatolian Black Parlak 6 mm Rektifiye / Anatolian Black Glossy 6 mm Rectified
88000011	Mat / Matt	6 mm	163 x 323 cm	Anatolian Black Mat 6 mm / Anatolian Black Matt 6 mm
88000011R	Mat / Matt	6 mm	160 x 320 cm	Anatolian Black Mat 6 mm Rektifiye / Anatolian Black Matt 6 mm Rectified

ANATOLIAN BLACK



12 MM $\frac{\updownarrow}{\updownarrow}$

PARLAK / GLOSSY

MAT / MATT

88000145ABP
88000145AB

Parlak / Glossy
Mat / Matt

12 mm
12 mm

83 x 323 cm
83 x 323 cm

Anatolian Black Parlak AB 12 mm / Anatolian Black Glossy AB 12 mm
Anatolian Black Mat AB 12 mm / Anatolian Black Matt AB 12 mm



NG | STONE
PORCELAIN SLABS

ANTIQUE BEIGE





ANTIQUÉ BEIGE



12 MM $\frac{1}{2}$

PARLAK / GLOSSY

SATINATO

SOFT MAT / SOFT MATT

88000012P	Parlak / Glossy	12 mm	163 x 323 cm	Antique Beige Parlak 12 mm / Antique Beige Glossy 12 mm
88000012RP	Parlak / Glossy	12 mm	160 x 320 cm	Antique Beige Parlak 12 mm Rektifiye / Antique Beige Glossy 12 mm Rectified
880000121P	Parlak / Glossy	12 mm	163 x 323 cm	Antique Beige Parlak Bookmatch 12 mm / Antique Beige Glossy Bookmatch 12 mm
880000121RP	Parlak / Glossy	12 mm	160 x 320 cm	Antique Beige Parlak Bookmatch 12 mm Rektifiye / Antique Beige Glossy Bookmatch 12 mm Rectified
88000012S	Satinato / Sat.	12 mm	163 x 323 cm	Antique Beige Satinato 12 mm / Antique Beige Satinato 12 mm
88000012RS	Satinato / Sat.	12 mm	160 x 320 cm	Antique Beige Satinato 12 mm Rektifiye / Antique Beige Satinato 12 mm Rectified
880000121S	Satinato / Sat.	12 mm	163 x 323 cm	Antique Beige Satinato Bookmatch 12 mm / Antique Beige Satinato Bookmatch 12 mm
880000121RS	Satinato / Sat.	12 mm	160 x 320 cm	Antique Beige Satinato Bookmatch 12 mm Rektifiye / Antique Beige Satinato Bookmatch 12 mm Rectified
880000012	Soft Mat / So. M.	12 mm	163 x 323 cm	Antique Beige Soft Mat 12 mm / Antique Beige Soft Matt 12 mm
880000012R	Soft Mat / So. M.	12 mm	160 x 320 cm	Antique Beige Soft Mat 12 mm Rektifiye / Antique Beige Soft Matt 12 mm Rectified
880000121	Soft Mat / So. M.	12 mm	163 x 323 cm	Antique Beige Soft Mat Bookmatch 12 mm / Antique Beige Soft Matt Bookmatch 12 mm
880000121R	Soft Mat / So. M.	12 mm	160 x 320 cm	Antique Beige Soft Mat Bookmatch 12 mm Rektifiye / Antique Beige Soft Matt Bookmatch 12 mm Rectified



6 MM $\frac{\downarrow}{\uparrow}$	PARLAK / GLOSSY	SATINATO	SOFT MAT / SOFT MATT	
88000013P	Parlak / Glossy	6 mm	163 x 323 cm	Antique Beige Parlak 6 mm / Antique Beige Glossy 6 mm
88000013RP	Parlak / Glossy	6 mm	160 x 320 cm	Antique Beige Parlak 6 mm Rektifiye / Antique Beige Glossy 6 mm Rectified
88000122P	Parlak / Glossy	6 mm	163 x 323 cm	Antique Beige Parlak Bookmatch 6 mm / Antique Beige Glossy Bookmatch 6 mm
88000122RP	Parlak / Glossy	6 mm	160 x 320 cm	Antique Beige Parlak Bookmatch 6 mm Rektifiye / Antique Beige Glossy Bookmatch 6 mm Rectified
88000013S	Satinato / Sat.	6 mm	163 x 323 cm	Antique Beige Satinato 6 mm / Antique Beige Satinato 6 mm
88000013RS	Satinato / Sat.	6 mm	160 x 320 cm	Antique Beige Satinato 6 mm Rektifiye / Antique Beige Satinato 6 mm Rectified
88000122S	Satinato / Sat.	6 mm	163 x 323 cm	Antique Beige Satinato Bookmatch 6 mm / Antique Beige Satinato Bookmatch 6 mm
88000122RS	Satinato / Sat.	6 mm	160 x 320 cm	Antique Beige Satinato Bookmatch 6 mm Rektifiye / Antique Beige Satinato Bookmatch 6 mm Rectified
88000013	Soft Mat / So. M.	6 mm	163 x 323 cm	Antique Beige Soft Mat 6 mm / Antique Beige Soft Matt 6 mm
88000013R	Soft Mat / So. M.	6 mm	160 x 320 cm	Antique Beige Soft Mat 6 mm Rektifiye / Antique Beige Soft Matt 6 mm Rectified
88000122	Soft Mat / So. M.	6 mm	163 x 323 cm	Antique Beige Soft Mat Bookmatch 6 mm / Antique Beige Soft Matt Bookmatch 6 mm
88000122R	Soft Mat / So. M.	6 mm	160 x 320 cm	Antique Beige Soft Mat Bookmatch 6 mm Rektifiye / Antique Beige Soft Matt Bookmatch 6 mm Rectified

ANTIQUÉ BEIGE



12 MM $\frac{1}{2}$

PARLAK / GLOSSY

SATINATO

SOFT MAT / SOFT MATT

88000146ABP	Parlak / Glossy	12 mm	83 x 323 cm	Antique Beige Parlak AB 12 mm / Antique Beige Glossy AB 12 mm
88000146ABS	Satinato / Sat.	12 mm	83 x 323 cm	Antique Beige Satinato AB 12 mm / Antique Beige Satinato AB 12 mm
88000146AB	Soft Mat / Matt	12 mm	83 x 323 cm	Antique Beige Soft Mat AB 12 mm / Antique Beige Soft Matt AB 12 mm



NG | STONE
PORCELAIN SLABS

ARABESCATO GILDA





ARABESCATO GILDA



12 MM $\frac{1}{2}$

PARLAK / GLOSSY

SATINATO

SOFT MAT / SOFT MATT

88000014P	Parlak / Glossy	12 mm	163 x 323 cm	Arabescato Gilda Parlak 12 mm / Arabescato Gilda Glossy 12 mm
88000014RP	Parlak / Glossy	12 mm	160 x 320 cm	Arabescato Gilda Parlak 12 mm Rektifiye / Arabescato Gilda Glossy 12 mm Rectified
88000014S	Satinato / Sat.	12 mm	163 x 323 cm	Arabescato Gilda Satinato 12 mm / Arabescato Gilda Satinato 12 mm
88000014RS	Satinato / Sat.	12 mm	160 x 320 cm	Arabescato Gilda Satinato 12 mm Rektifiye / Arabescato Gilda Satinato 12 mm Rectified
88000014	Soft Mat / So. M.	12 mm	163 x 323 cm	Arabescato Gilda Soft Mat 12 mm / Arabescato Gilda Soft Matt 12 mm
88000014R	Soft Mat / So. M.	12 mm	160 x 320 cm	Arabescato Gilda Soft Mat 12 mm Rektifiye / Arabescato Gilda Soft Matt 12 mm Rectified



6 MM $\frac{\downarrow}{\uparrow}$

PARLAK / GLOSSY

SATINATO

SOFT MAT / SOFT MATT

88000015P	Parlak / Glossy	6 mm	163 x 323 cm	Arabescato Gilda Parlak 6 mm / Arabescato Gilda Glossy 6 mm
88000015RP	Parlak / Glossy	6 mm	160 x 320 cm	Arabescato Gilda Parlak 6 mm Rektifiye / Arabescato Gilda Glossy 6 mm Rectified
88000015S	Satinato / Sat.	6 mm	163 x 323 cm	Arabescato Gilda Satinato 6 mm / Arabescato Gilda Satinato 6 mm
88000015RS	Satinato / Sat.	6 mm	160 x 320 cm	Arabescato Gilda Satinato 6 mm Rektifiye / Arabescato Gilda Satinato 6 mm Rectified
88000015	Soft Mat / So. M.	6 mm	163 x 323 cm	Arabescato Gilda Soft Mat 6 mm / Arabescato Gilda Soft Matt 6 mm
88000015R	Soft Mat / So. M.	6 mm	160 x 320 cm	Arabescato Gilda Soft Mat 6 mm Rektifiye / Arabescato Gilda Soft Matt 6 mm Rectified

ARABESCATO GILDA



12 MM $\frac{\updownarrow}{\updownarrow}$

6 MM $\frac{\updownarrow}{\updownarrow}$

PARLAK / GLOSSY

SATINATO

SOFT MAT / SOFT MATT

88000123P	Parlak / Glossy	12 mm	163 x 323 cm	Arabescato Gilda Parlak Bookmatch 12 mm / Arabescato Gilda Glossy Bookmatch 12 mm
88000123RP	Parlak / Glossy	12 mm	160 x 320 cm	Arabescato Gilda Parlak Bookmatch 12 mm Rektifiye / Arabescato Gilda Glossy Bookmatch 12 mm Rectified
88000123S	Satinato / Sat.	12 mm	163 x 323 cm	Arabescato Gilda Satinato Bookmatch 12 mm / Arabescato Gilda Satinato Bookmatch 12 mm
88000123RS	Satinato / Sat.	12 mm	160 x 320 cm	Arabescato Gilda Satinato Bookmatch 12 mm Rektifiye / Arabescato Gilda Satinato Bookmatch 12 mm Rectified
88000123	Soft Mat / So. M.	12 mm	163 x 323 cm	Arabescato Gilda Soft Mat Bookmatch 12 mm / Arabescato Gilda Soft Matt Bookmatch 12 mm
88000123R	Soft Mat / So. M.	12 mm	160 x 320 cm	Arabescato Gilda Soft Mat Bookmatch 12 mm Rektifiye / Arabescato Gilda Soft Matt Bookmatch 12 mm Rectified
88000124P	Parlak / Glossy	6 mm	163 x 323 cm	Arabescato Gilda Parlak Bookmatch 6 mm / Arabescato Gilda Glossy Bookmatch 6 mm
88000124RP	Parlak / Glossy	6 mm	160 x 320 cm	Arabescato Gilda Parlak Bookmatch 6 mm Rektifiye / Arabescato Gilda Glossy Bookmatch 6 mm Rectified
88000124S	Satinato / Sat.	6 mm	163 x 323 cm	Arabescato Gilda Satinato Bookmatch 6 mm / Arabescato Gilda Satinato Bookmatch 6 mm
88000124RS	Satinato / Sat.	6 mm	160 x 320 cm	Arabescato Gilda Satinato Bookmatch 6 mm Rektifiye / Arabescato Gilda Satinato Bookmatch 6 mm Rectified
88000124	Soft Mat / So. M.	6 mm	163 x 323 cm	Arabescato Gilda Soft Mat Bookmatch 6 mm / Arabescato Gilda Soft Matt Bookmatch 6 mm
88000124R	Soft Mat / So. M.	6 mm	160 x 320 cm	Arabescato Gilda Soft Mat Bookmatch 6 mm Rektifiye / Arabescato Gilda Soft Matt Bookmatch 6 mm Rectified



12 MM $\frac{\updownarrow}{\updownarrow}$

PARLAK / GLOSSY

SATINATO

SOFT MAT / SOFT MATT

88000147ABP	Parlak / Glossy	12 mm	83 x 323 cm	Arabescato Gilda Parlak AB 12 mm / Arabescato Gilda Glossy AB 12 mm
88000147ABS	Satinato / Sat.	12 mm	83 x 323 cm	Arabescato Gilda Satinato AB 12 mm / Arabescato Gilda Satinato AB 12 mm
88000147AB	Soft Mat / So. M.	12 mm	83 x 323 cm	Arabescato Gilda Soft Mat AB 12 mm / Arabescato Gilda Soft Matt AB 12 mm

BAMBOO NOIR



12 MM $\frac{1}{2}$

PARLAK / GLOSSY

MAT / MATT

88000086P	Parlak / Glossy	12 mm	163 x 323 cm	Bamboo Noir Parlak 12 mm / Bamboo Noir Glossy 12 mm
88000207RP	Parlak / Glossy	12 mm	160 x 320 cm	Bamboo Noir Parlak 12 mm Rektifiye / Bamboo Noir Glossy 12 mm Rectified
88000086	Mat / Matt	12 mm	163 x 323 cm	Bamboo Noir Mat 12 mm / Bamboo Noir Matt 12 mm
88000207R	Mat / Matt	12 mm	160 x 320 cm	Bamboo Noir Mat 12 mm Rektifiye / Bamboo Noir Matt 12 mm Rectified

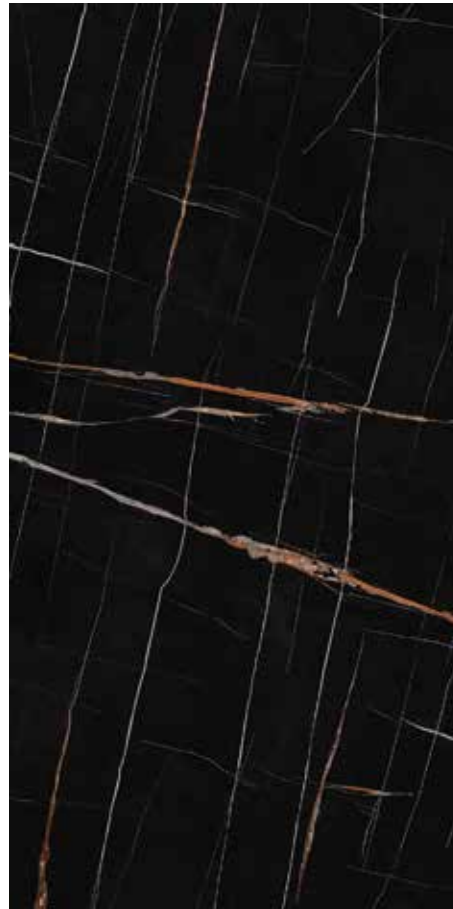

6 MM $\frac{\downarrow}{\uparrow}$

PARLAK / GLOSSY

MAT / MATT

88000202P	Parlak / Glossy	6 mm	163 x 323 cm	Bamboo Noir Parlak 6 mm / Bamboo Noir Glossy 6 mm
88000202RP	Parlak / Glossy	6 mm	160 x 320 cm	Bamboo Noir Parlak 6 mm Rektifiye / Bamboo Noir Glossy 6 mm Rectified
88000202	Mat / Matt	6 mm	163 x 323 cm	Bamboo Noir Mat 6 mm / Bamboo Noir Matt 6 mm
88000202R	Mat / Matt	6 mm	160 x 320 cm	Bamboo Noir Mat 6 mm Rektifiye / Bamboo Noir Matt 6 mm Rectified

BAMBOO NOIR



12 MM $\frac{\updownarrow}{\updownarrow}$

PARLAK / GLOSSY

MAT / MATT

88000158ABP
88000158AB

Parlak / Glossy
Mat / Matt

12 mm
12 mm

83 x 323 cm
83 x 323 cm

Bamboo Noir Parlak AB 12 mm / Bamboo Noir Glossy AB 12 mm
Bamboo Noir Mat AB 12 mm / Bamboo Noir Matt AB 12 mm



NG | STONE
PORCELAIN SLABS

CALACATTA GOLD





CALACATTA GOLD



12 MM $\frac{1}{2}$

PARLAK / GLOSSY

SATINATO

SOFT MAT / SOFT MATT

88000016P	Parlak / Glossy	12 mm	163 x 323 cm	Calacatta Gold Parlak 12 mm / Calacatta Gold Glossy 12 mm
88000016RP	Parlak / Glossy	12 mm	160 x 320 cm	Calacatta Gold Parlak 12 mm Rektifiye / Calacatta Gold Glossy 12 mm Rectified
88000016S	Satinato / Sat.	12 mm	163 x 323 cm	Calacatta Gold Satinato 12 mm / Calacatta Gold Satinato 12 mm
88000016RS	Satinato / Sat.	12 mm	160 x 320 cm	Calacatta Gold Satinato 12 mm Rektifiye / Calacatta Gold Satinato 12 mm Rectified
88000016	Soft Mat / So. M.	12 mm	163 x 323 cm	Calacatta Gold Soft Mat 12 mm / Calacatta Gold Soft Matt 12 mm
88000016R	Soft Mat / So. M.	12 mm	160 x 320 cm	Calacatta Gold Soft Mat 12 mm Rektifiye / Calacatta Gold Soft Matt 12 mm Rectified



6 MM $\frac{\downarrow}{\uparrow}$

PARLAK / GLOSSY

SATINATO

SOFT MAT / SOFT MATT

88000017P	Parlak / Glossy	6 mm	163 x 323 cm	Calacatta Gold Parlak 6 mm / Calacatta Gold Glossy 6 mm
88000017RP	Parlak / Glossy	6 mm	160 x 320 cm	Calacatta Gold Parlak 6 mm Rektifiye / Calacatta Gold Glossy 6 mm Rectified
88000017S	Satinato / Sat.	6 mm	163 x 323 cm	Calacatta Gold Satinato 6 mm / Calacatta Gold Satinato 6 mm
88000017RS	Satinato / Sat.	6 mm	160 x 320 cm	Calacatta Gold Satinato 6 mm Rektifiye / Calacatta Gold Satinato 6 mm Rectified
88000017	Soft Mat / So. M.	6 mm	163 x 323 cm	Calacatta Gold Soft Mat 6 mm / Calacatta Gold Soft Matt 6 mm
88000017R	Soft Mat / So. M.	6 mm	160 x 320 cm	Calacatta Gold Soft Mat 6 mm Rektifiye / Calacatta Gold Soft Matt 6 mm Rectified

CALACATTA GOLD



12 MM $\frac{1}{2}$	6 MM $\frac{1}{2}$	PARLAK / GLOSSY	SATINATO	SOFT MAT / SOFT MATT
---------------------	--------------------	-----------------	----------	----------------------

88000125P	Parlak / Glossy	12 mm	163 x 323 cm	Calacatta Gold Parlak Bookmatch 12 mm / Calacatta Gold Glossy Bookmatch 12 mm
88000125RP	Parlak / Glossy	12 mm	160 x 320 cm	Calacatta Gold Parlak Bookmatch 12 mm Rektifiye / Calacatta Gold Glossy Bookmatch 12 mm Rectified
88000125S	Satinato / Sat.	12 mm	163 x 323 cm	Calacatta Gold Satinato Bookmatch 12 mm / Calacatta Gold Satinato Bookmatch 12 mm
88000125RS	Satinato / Sat.	12 mm	160 x 320 cm	Calacatta Gold Satinato Bookmatch 12 mm Rektifiye / Calacatta Gold Satinato Bookmatch 12 mm Rectified
88000125	Soft Mat / So. M.	12 mm	163 x 323 cm	Calacatta Gold Soft Mat Bookmatch 12 mm / Calacatta Gold Soft Matt Bookmatch 12 mm
88000125R	Soft Mat / So. M.	12 mm	160 x 320 cm	Calacatta Gold Soft Mat Bookmatch 12 mm Rektifiye / Calacatta Gold Soft Matt Bookmatch 12 mm Rectified
88000126P	Parlak / Glossy	6 mm	163 x 323 cm	Calacatta Gold Parlak Bookmatch 6 mm / Calacatta Gold Glossy Bookmatch 6 mm
88000126RP	Parlak / Glossy	6 mm	160 x 320 cm	Calacatta Gold Parlak Bookmatch 6 mm Rektifiye / Calacatta Gold Glossy Bookmatch 6 mm Rectified
88000126S	Satinato / Sat.	6 mm	163 x 323 cm	Calacatta Gold Satinato Bookmatch 6 mm / Calacatta Gold Satinato Bookmatch 6 mm
88000126RS	Satinato / Sat.	6 mm	160 x 320 cm	Calacatta Gold Satinato Bookmatch 6 mm Rektifiye / Calacatta Gold Satinato Bookmatch 6 mm Rectified
88000126	Soft Mat / So. M.	6 mm	163 x 323 cm	Calacatta Gold Soft Mat Bookmatch 6 mm / Calacatta Gold Soft Matt Bookmatch 6 mm
88000126R	Soft Mat / So. M.	6 mm	160 x 320 cm	Calacatta Gold Soft Mat Bookmatch 6 mm Rektifiye / Calacatta Gold Soft Matt Bookmatch 6 mm Rectified



12 MM $\frac{1}{2}$

PARLAK / GLOSSY

SATINATO

SOFT MAT / SOFT MATT

88000175ABP	Parlak / Glossy	12 mm	83 x 323 cm	Calacatta Gold Parlak AB 12 mm / Calacatta Gold Glossy AB 12 mm
88000148ABS	Satinato / Sat.	12 mm	83 x 323 cm	Calacatta Gold Satinato AB 12 mm / Calacatta Gold Satinato AB 12 mm
88000148AB	Soft Mat / So. M.	12 mm	83 x 323 cm	Calacatta Gold Soft Mat AB 12 mm / Calacatta Gold Soft Matt AB 12 mm

CRYSTAL LUXOR





CRYSTAL LUXOR



12 MM $\frac{1}{2}$

PARLAK / GLOSSY

SATINATO

88000020P	Parlak / Glossy	12 mm	163 x 323 cm	Crystal Luxor Parlak 12 mm / Crystal Luxor Glossy 12 mm
88000020RP	Parlak / Glossy	12 mm	160 x 320 cm	Crystal Luxor Parlak 12 mm Rektifiye / Crystal Luxor Glossy 12 mm Rectified
88000020S	Satinato / Sat.	12 mm	163 x 323 cm	Crystal Luxor Satinato 12 mm / Crystal Luxor Satinato 12 mm
88000020RS	Satinato / Sat.	12 mm	160 x 320 cm	Crystal Luxor Satinato 12 mm Rektifiye / Crystal Luxor Satinato 12 mm Rectified



6 MM $\frac{\downarrow}{\uparrow}$

PARLAK / GLOSSY

SATINATO

88000021P	Parlak / Glossy	6 mm	163 x 323 cm	Crystal Luxor Parlak 6 mm / Crystal Luxor Glossy 6 mm
88000021RP	Parlak / Glossy	6 mm	160 x 320 cm	Crystal Luxor Parlak 6 mm Rektifiye / Crystal Luxor Glossy 6 mm Rectified
88000021S	Satinato / Sat.	6 mm	163 x 323 cm	Crystal Luxor Satinato 6 mm / Crystal Luxor Satinato 6 mm
88000021RS	Satinato / Sat.	6 mm	160 x 320 cm	Crystal Luxor Satinato 6 mm Rektifiye / Crystal Luxor Satinato 6 mm Rectified

CRYSTAL LUXOR



12 MM $\frac{1}{2}$

PARLAK / GLOSSY

SATINATO

88000076P
88000076S

Parlak / Glossy
Satinato / Sat.

12 mm
12 mm

83 x 323 cm
83 x 323 cm

Crystal Luxor Parlak 12 mm / Crystal Luxor Glossy 12 mm
Crystal Luxor Satinato 12 mm / Crystal Luxor Satinato 12 mm

The background of the image is a close-up of a porcelain slab with a marbled pattern. The colors are primarily light beige and off-white, with intricate, vein-like patterns in shades of tan, gold, and light brown. The texture appears smooth but with natural-looking variations in tone and pattern.

NG | **STONE**
PORCELAIN SLABS

DELMAR







12 MM $\frac{1}{2}$

PARLAK / GLOSSY

88000022P	Parlak / Glossy	12 mm	163 x 323 cm	Delmar Parlak 12 mm / Delmar Glossy 12 mm
88000022RP	Parlak / Glossy	12 mm	160 x 320 cm	Delmar Parlak 12 mm Rektifiye / Delmar Glossy 12 mm Rectified



6 MM $\frac{\downarrow}{\uparrow}$

PARLAK / GLOSSY

88000023P	Parlak / Glossy	6 mm	163 x 323 cm	Delmar Parlak 6 mm / Delmar Glossy 6 mm
88000023RP	Parlak / Glossy	6 mm	160 x 320 cm	Delmar Parlak 6 mm Rektifiye / Delmar Glossy 6 mm Rectified

DELMAR

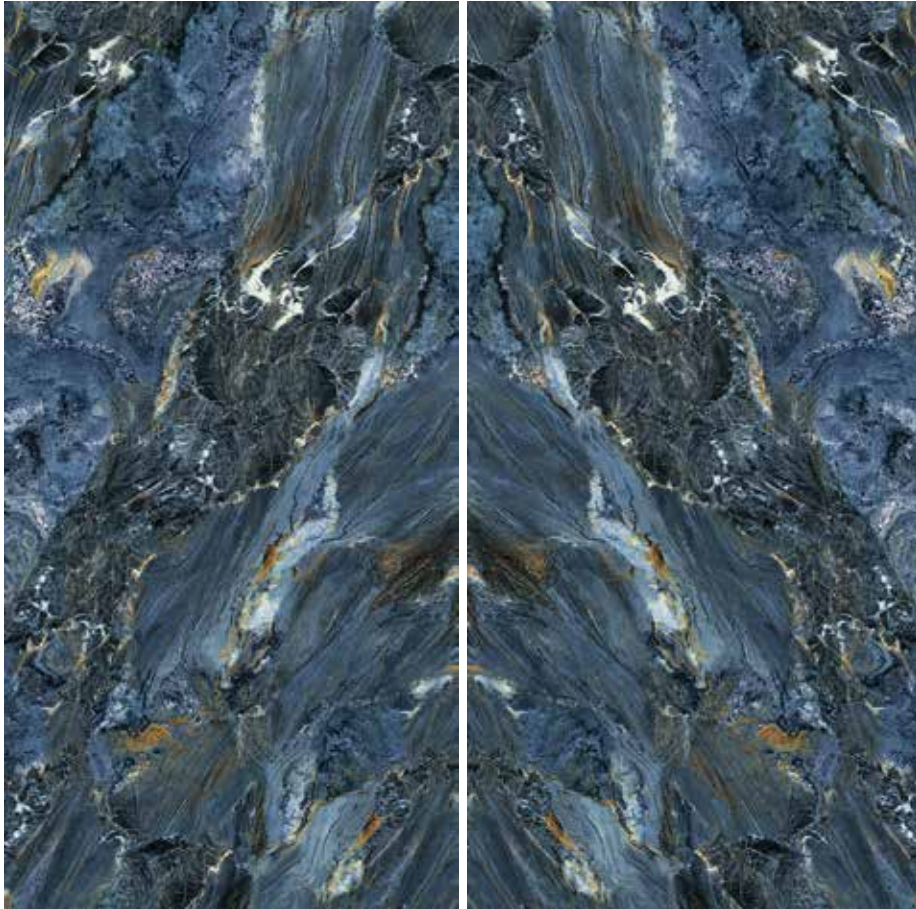

12 MM $\frac{\updownarrow}{\updownarrow}$

6 MM $\frac{\updownarrow}{\updownarrow}$

PARLAK / GLOSSY

88000127P	Parlak / Glossy	12 mm	163 x 323 cm	Delmar Parlak Bookmatch 12 mm / Delmar Glossy Bookmatch 12 mm
88000127RP	Parlak / Glossy	12 mm	160 x 320 cm	Delmar Parlak Bookmatch 12 mm Rektifiye / Delmar Glossy Bookmatch 12 mm Rectified
88000128P	Parlak / Glossy	6 mm	163 x 323 cm	Delmar Parlak Bookmatch 6 mm / Delmar Glossy Bookmatch 6 mm
88000128RP	Parlak / Glossy	6 mm	160 x 320 cm	Delmar Parlak Bookmatch 6 mm Rektifiye / Delmar Glossy Bookmatch 6 mm Rectified



NG | STONE
PORCELAIN SLABS

DOLOMIT



12 MM $\frac{1}{2}$

PARLAK / GLOSSY

SATINATO

SOFT MAT / SOFT MATT

88000142P	Parlak / Glossy	12 mm	163 x 323 cm	Dolomit Parlak 12 mm / Dolomit Glossy 12 mm
88000142RP	Parlak / Glossy	12 mm	160 x 320 cm	Dolomit Parlak 12 mm Rektifiye / Dolomit Glossy 12 mm Rectified
88000142S	Satinato / Sat.	12 mm	163 x 323 cm	Dolomit Satinato 12 mm / Dolomit Satinato 12 mm
88000142RS	Satinato / Sat.	12 mm	160 x 320 cm	Dolomit Satinato 12 mm Rektifiye / Dolomit Satinato 12 mm Rectified
88000142	Soft Mat / So. M.	12 mm	163 x 323 cm	Dolomit Soft Mat 12 mm / Dolomit Soft Matt 12 mm
88000142R	Soft Mat / So. M.	12 mm	160 x 320 cm	Dolomit Soft Mat 12 mm Rektifiye / Dolomit Soft Matt 12 mm Rectified



6 MM $\frac{\downarrow}{\uparrow}$	PARLAK / GLOSSY	SATINATO	SOFT MAT / SOFT MATT	
88000194P	Parlak / Glossy	6 mm	163 x 323 cm	Dolomit Parlak 6 mm / Dolomit Glossy 6 mm
88000194RP	Parlak / Glossy	6 mm	160 x 320 cm	Dolomit Parlak 6 mm Rektifiye / Dolomit Glossy 6 mm Rectified
88000194S	Satinato / Sat.	6 mm	163 x 323 cm	Dolomit Satinato 6 mm / Dolomit Satinato 6 mm
88000194RS	Satinato / Sat.	6 mm	160 x 320 cm	Dolomit Satinato 6 mm Rektifiye / Dolomit Satinato 6 mm Rectified
88000194	Soft Mat / So. M.	6 mm	163 x 323 cm	Dolomit Soft Mat 6 mm / Dolomit Soft Matt 6 mm
88000194R	Soft Mat / So. M.	6 mm	160 x 320 cm	Dolomit Soft Mat 6 mm Rektifiye / Dolomit Soft Matt 6 mm Rectified

DOLOMIT



12 MM $\frac{\updownarrow}{\updownarrow}$

PARLAK / GLOSSY

SATINATO

SOFT MAT / SOFT MATT

88000178P	Parlak / Glossy	12 mm	83 x 323 cm	Dolomit Parlak 12 mm / Dolomit Glossy 12 mm
88000178S	Satinato / Sat.	12 mm	83 x 323 cm	Dolomit Satinato 12 mm / Dolomit Satinato 12 mm
88000178	Soft Mat / So. M.	12 mm	83 x 323 cm	Dolomit Soft Mat 12 mm / Dolomit Soft Matt 12 mm

NG | STONE
PORCELAIN SLABS

EGEAN BROWN



12 MM $\frac{1}{2}$

PARLAK / GLOSSY

MAT / MATT

88000024P	Parlak / Glossy	12 mm	163 x 323 cm	Egean Brown Parlak 12 mm / Egean Brown Glossy 12 mm
88000024RP	Parlak / Glossy	12 mm	160 x 320 cm	Egean Brown Parlak 12 mm Rektifiye / Egean Brown Glossy 12 mm Rectified
88000024	Mat / Matt	12 mm	163 x 323 cm	Egean Brown Mat 12 mm / Egean Brown Matt 12 mm
88000024R	Mat / Matt	12 mm	160 x 320 cm	Egean Brown Mat 12 mm Rektifiye / Egean Brown Matt 12 mm Rectified

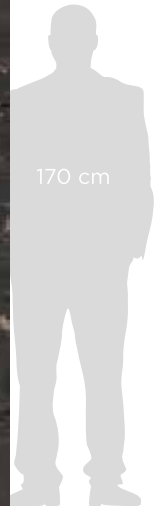

6 MM $\frac{\downarrow}{\uparrow}$	PARLAK / GLOSSY	MAT / MATT
------------------------------------	------------------------	-------------------

88000025P	Parlak / Glossy	6 mm	163 x 323 cm	Egean Brown Parlak 6 mm / Egean Brown Glossy 6 mm
88000025RP	Parlak / Glossy	6 mm	160 x 320 cm	Egean Brown Parlak 6 mm Rektifiye / Egean Brown Glossy 6 mm Rectified
88000025	Mat / Matt	6 mm	163 x 323 cm	Egean Brown Mat 6 mm / Egean Brown Matt 6 mm
88000025R	Mat / Matt	6 mm	160 x 320 cm	Egean Brown Mat 6 mm Rektifiye / Egean Brown Matt 6 mm Rectified

EGEAN BROWN



12 MM $\frac{\updownarrow}{\updownarrow}$

PARLAK / GLOSSY

MAT / MATT

88000152ABP	Parlak / Glossy	12 mm	83 x 323 cm	Egean Brown Parlak AB 12 mm / Egean Brown Glossy AB 12 mm
88000152AB	Mat / Matt	12 mm	83 x 323 cm	Egean Brown Mat AB 12 mm / Egean Brown Matt AB 12 mm

The background is a dark, almost black, marbled surface with intricate, irregular white and light grey veins. The veins vary in thickness and direction, creating a complex, organic pattern. The overall appearance is that of a high-quality, dark-toned marble or stone.

NG | STONE
PORCELAIN SLABS

EMERALD GREEN



House of Cards
★★★★★ 2013 (IMDb) 1 Season (TV-14)

Sharks gliding ominously beneath the surface of the water? They're a lot less menacing than this Congressman.

This winner of three Emmys, including Outstanding Directing for David Fincher, stars Kevin Spacey and Robin Wright.

Because you watched Orange Is the New Black

Because you watched Red Lights





EMERALD GREEN



12 MM $\frac{1}{2}$

PARLAK / GLOSSY

SATINATO

88000028P	Parlak / Glossy	12 mm	163 x 323 cm	Emerald Green Parlak 12 mm / Emerald Green Glossy 12 mm
88000028RP	Parlak / Glossy	12 mm	160 x 320 cm	Emerald Green Parlak 12 mm Rektifiye / Emerald Green Glossy 12 mm Rectified
88000028S	Satinato / Sat.	12 mm	163 x 323 cm	Emerald Green Satinato 12 mm / Emerald Green Satinato 12 mm
88000028RS	Satinato / Sat.	12 mm	160 x 320 cm	Emerald Green Satinato 12 mm Rektifiye / Emerald Green Satinato 12 mm Rectified



6 MM $\frac{\downarrow}{\uparrow}$

PARLAK / GLOSSY

SATINATO

88000029P	Parlak / Glossy	6 mm	163 x 323 cm	Emerald Green Parlak 6 mm / Emerald Green Glossy 6 mm
88000029RP	Parlak / Glossy	6 mm	160 x 320 cm	Emerald Green Parlak 6 mm Rektifiye / Emerald Green Glossy 6 mm Rectified
88000029S	Satinato / Sat.	6 mm	163 x 323 cm	Emerald Green Satinato 6 mm / Emerald Green Satinato 6 mm
88000029RS	Satinato / Sat.	6 mm	160 x 320 cm	Emerald Green Satinato 6 mm Rektifiye / Emerald Green Satinato 6 mm Rectified

EMERALD GREEN



12 MM $\frac{1}{2}$

PARLAK / GLOSSY

SATINATO

88000154ABP	Parlak / Glossy	12 mm	83 x 323 cm	Emerald Green Parlak AB 12 mm / Emerald Green Glossy AB 12 mm
88000154ABS	Satinato / Sat.	12 mm	83 x 323 cm	Emerald Green Satinato AB 12 mm / Emerald Green Satinato AB 12 mm



NG | STONE
PORCELAIN SLABS

HONEY ONYX





HONEY ONYX



12 MM $\frac{\downarrow}{\uparrow}$

PARLAK / GLOSSY

88000030P	Parlak / Glossy	12 mm	163 x 323 cm	Honey Onyx Parlak 12 mm / Honey Onyx Glossy 12 mm
88000030RP	Parlak / Glossy	12 mm	160 x 320 cm	Honey Onyx Parlak 12 mm Rektifiye / Honey Onyx Glossy 12 mm Rectified



6 MM $\frac{\downarrow}{\uparrow}$

PARLAK / GLOSSY

88000031P
88000031RP

Parlak / Glossy
Parlak / Glossy

6 mm
6 mm

163 x 323 cm
160 x 320 cm

Honey Onyx Parlak 6 mm / Honey Onyx Glossy 6 mm
Honey Onyx Parlak 6 mm Rektifiye / Honey Onyx Glossy 6 mm Rectified

HONEY ONYX



12 MM $\frac{\updownarrow}{\updownarrow}$

PARLAK / GLOSSY

88000097P | Parlak / Glossy | 12 mm | 83 x 323 cm | Honey Onyx Parlak 12 mm / Honey Onyx Glossy 12 mm



NG | STONE
PORCELAIN SLABS

INVISIBLE WHITE





INVISIBLE WHITE



12 MM $\frac{1}{2}$

PARLAK / GLOSSY

SATINATO

SOFT MAT / SOFT MATT

88000032P	Parlak / Glossy	12 mm	163 x 323 cm	Invisible White Parlak 12 mm / Invisible White Glossy 12 mm
88000032RP	Parlak / Glossy	12 mm	160 x 320 cm	Invisible White Parlak 12 mm Rektifiye / Invisible White Glossy 12 mm Rectified
88000032S	Satinato / Sat.	12 mm	163 x 323 cm	Invisible White Satinato 12 mm / Invisible White Satinato 12 mm
88000032RS	Satinato / Sat.	12 mm	160 x 320 cm	Invisible White Satinato 12 mm Rektifiye / Invisible White Satinato 12 mm Rectified
88000032	Soft Mat / So. M.	12 mm	163 x 323 cm	Invisible White Soft Mat 12 mm / Invisible White Soft Matt 12 mm
88000032R	Soft Mat / So. M.	12 mm	160 x 320 cm	Invisible White Soft Mat 12 mm Rektifiye / Invisible White Soft Matt 12 mm Rectified



6 MM $\frac{\downarrow}{\uparrow}$	PARLAK / GLOSSY	SATINATO	SOFT MAT / SOFT MATT
---	------------------------	-----------------	-----------------------------

88000033P	Parlak / Glossy	6 mm	163 x 323 cm	Invisible White Parlak 6 mm / Invisible White Glossy 6 mm
88000033RP	Parlak / Glossy	6 mm	160 x 320 cm	Invisible White Parlak 6 mm Rektifiye / Invisible White Glossy 6 mm Rectified
88000033S	Satinato / Sat.	6 mm	163 x 323 cm	Invisible White Satinato 6 mm / Invisible White Satinato 6 mm
88000033RS	Satinato / Sat.	6 mm	160 x 320 cm	Invisible White Satinato 6 mm Rektifiye / Invisible White Satinato 6 mm Rectified
88000033	Soft Mat / So. M.	6 mm	163 x 323 cm	Invisible White Soft Mat 6 mm / Invisible White Soft Matt 6 mm
88000033R	Soft Mat / So. M.	6 mm	160 x 320 cm	Invisible White Soft Mat 6 mm Rektifiye / Invisible White Soft Matt 6 mm Rectified

INVISIBLE WHITE



12 MM $\frac{\updownarrow}{\updownarrow}$

6 MM $\frac{\updownarrow}{\updownarrow}$

PARLAK / GLOSSY

SATINATO

SOFT MAT / SOFT MATT

88000129P	Parlak / Glossy	12 mm	163 x 323 cm	Invisible White Parlak Bookmatch 12 mm / Invisible White Glossy Bookmatch 12 mm
88000129RP	Parlak / Glossy	12 mm	160 x 320 cm	Invisible White Parlak Bookmatch 12 mm Rektifiye / Invisible White Glossy Bookmatch 12 mm Rectified
88000129S	Satinato / Sat.	12 mm	163 x 323 cm	Invisible White Satinato Bookmatch 12 mm / Invisible White Satinato Bookmatch 12 mm
88000129RS	Satinato / Sat.	12 mm	160 x 320 cm	Invisible White Satinato Bookmatch 12 mm Rektifiye / Invisible White Satinato Bookmatch 12 mm Rectified
88000129	Soft Mat / So. M.	12 mm	163 x 323 cm	Invisible White Soft Mat Bookmatch 12 mm / Invisible White Soft Matt Bookmatch 12 mm
88000129R	Soft Mat / So. M.	12 mm	160 x 320 cm	Invisible White Soft Mat Bookmatch 12 mm Rektifiye / Invisible White Soft Matt Bookmatch 12 mm Rectified
88000130P	Parlak / Glossy	6 mm	163 x 323 cm	Invisible White Parlak Bookmatch 6 mm / Invisible White Glossy Bookmatch 6 mm
88000130RP	Parlak / Glossy	6 mm	160 x 320 cm	Invisible White Parlak Bookmatch 6 mm Rektifiye / Invisible White Glossy Bookmatch 6 mm Rectified
88000130S	Satinato / Sat.	6 mm	163 x 323 cm	Invisible White Satinato Bookmatch 6 mm / Invisible White Satinato Bookmatch 6 mm
88000130RS	Satinato / Sat.	6 mm	160 x 320 cm	Invisible White Satinato Bookmatch 6 mm Rektifiye / Invisible White Satinato Bookmatch 6 mm Rectified
88000130	Soft Mat / So. M.	6 mm	163 x 323 cm	Invisible White Soft Mat Bookmatch 6 mm / Invisible White Soft Matt Bookmatch 6 mm
88000130R	Soft Mat / So. M.	6 mm	160 x 320 cm	Invisible White Soft Mat Bookmatch 6 mm Rektifiye / Invisible White Soft Matt Bookmatch 6 mm Rectified



12 MM $\frac{1}{2}$

PARLAK / GLOSSY

SATINATO

SOFT MAT / SOFT MATT

88000156ABP	Parlak / Glossy	12 mm	83 x 323 cm	Invisible White Parlak AB 12 mm / Invisible White Glossy AB 12 mm
88000156ABS	Satinato / Sat.	12 mm	83 x 323 cm	Invisible White Satinato AB 12 mm / Invisible White Satinato AB 12 mm
88000156AB	Soft Mat / So. M.	12 mm	83 x 323 cm	Invisible White Soft Mat AB 12 mm / Invisible White Soft Matt AB 12 mm

LINE WHITE





LINE WHITE



12 MM $\frac{1}{2}$

PARLAK / GLOSSY

SATINATO

SOFT MAT / SOFT MATT

88000034P	Parlak / Glossy	12 mm	163 x 323 cm	Line White Parlak 12 mm / Line White Glossy 12 mm
88000034RP	Parlak / Glossy	12 mm	160 x 320 cm	Line White Parlak 12 mm Rektifiye / Line White Glossy 12 mm Rectified
88000034S	Satinato / Sat.	12 mm	163 x 323 cm	Line White Satinato 12 mm / Line White Satinato 12 mm
88000034RS	Satinato / Sat.	12 mm	160 x 320 cm	Line White Satinato 12 mm Rektifiye / Line White Satinato 12 mm Rectified
88000034	Soft Mat / So. M.	12 mm	163 x 323 cm	Line White Soft Mat 12 mm / Line White Soft Matt 12 mm
88000034R	Soft Mat / So. M.	12 mm	160 x 320 cm	Line White Soft Mat 12 mm Rektifiye / Line White Soft Matt 12 mm Rectified



6 MM $\frac{\downarrow}{\uparrow}$	PARLAK / GLOSSY	SATINATO	SOFT MAT / SOFT MATT
---	------------------------	-----------------	-----------------------------

88000035P	Parlak / Glossy	6 mm	163 x 323 cm	Line White Parlak 6 mm / Line White Glossy 6 mm
88000035RP	Parlak / Glossy	6 mm	160 x 320 cm	Line White Parlak 6 mm Rektifiye / Line White Glossy 6 mm Rectified
88000035S	Satinato / Sat.	6 mm	163 x 323 cm	Line White Satinato 6 mm / Line White Satinato 6 mm
88000035RS	Satinato / Sat.	6 mm	160 x 320 cm	Line White Satinato 6 mm Rektifiye / Line White Satinato 6 mm Rectified
88000035	Soft Mat / So. M.	6 mm	163 x 323 cm	Line White Soft Mat 6 mm / Line White Soft Matt 6 mm
88000035R	Soft Mat / So. M.	6 mm	160 x 320 cm	Line White Soft Mat 6 mm Rektifiye / Line White Soft Matt 6 mm Rectified

LINE WHITE



12 MM $\frac{1}{2}$

PARLAK / GLOSSY

SATINATO

SOFT MAT / SOFT MATT

88000157ABP	Parlak / Glossy	12 mm	83 x 323 cm	Line White Parlak AB 12 mm / Line White Glossy AB 12 mm
88000157ABS	Parlak / Glossy	12 mm	83 x 323 cm	Line White Satinato AB 12 mm / Line White Satinato AB 12 mm
88000157AB	Soft Mat / So. M.	12 mm	83 x 323 cm	Line White Soft Mat AB 12 mm / Line White Soft Matt AB 12 mm



NG | **STONE**
PORCELAIN SLABS

NERO MARQUINA





NERO MARQUINA



12 MM $\frac{1}{2}$

PARLAK / GLOSSY

88000036P	Parlak / Glossy	12 mm	163 x 323 cm	Nero Marquina Parlak 12 mm / Nero Marquina Glossy 12 mm
88000036RP	Parlak / Glossy	12 mm	160 x 320 cm	Nero Marquina Parlak 12 mm Rektifiye / Nero Marquina Glossy 12 mm Rectified



6 MM $\frac{\downarrow}{\uparrow}$

PARLAK / GLOSSY

88000037P
88000037RP

Parlak / Glossy
Parlak / Glossy

6 mm
6 mm

163 x 323 cm
160 x 320 cm

Nero Marquina Parlak 6 mm / Nero Marquina Glossy 6 mm
Nero Marquina Parlak 6 mm Rektifiye / Nero Marquina Glossy 6 mm Rectified

NERO MARQUINA

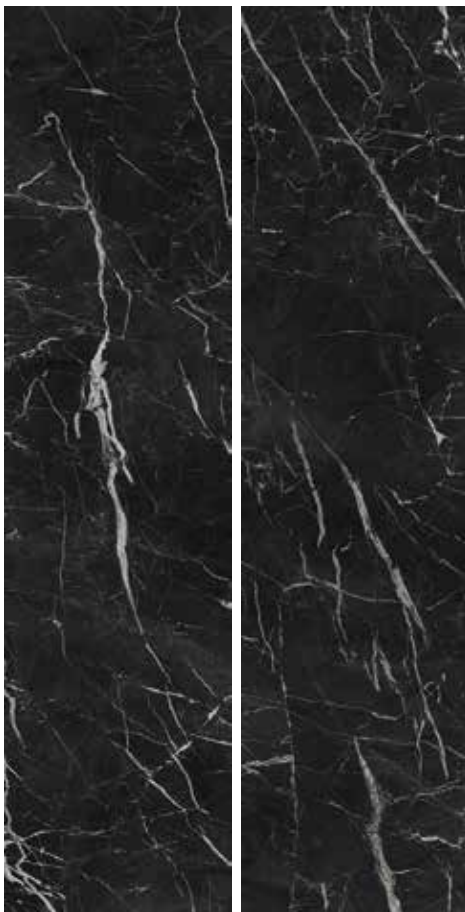

12 MM $\frac{\updownarrow}{\updownarrow}$

PARLAK / GLOSSY

88000074P | Parlak / Glossy | 12 mm | 83 x 323 cm | Nero Marquina Parlak 12 mm / Nero Marquina Glossy 12 mm



NG | STONE
PORCELAIN SLABS

OSSO





OSSO

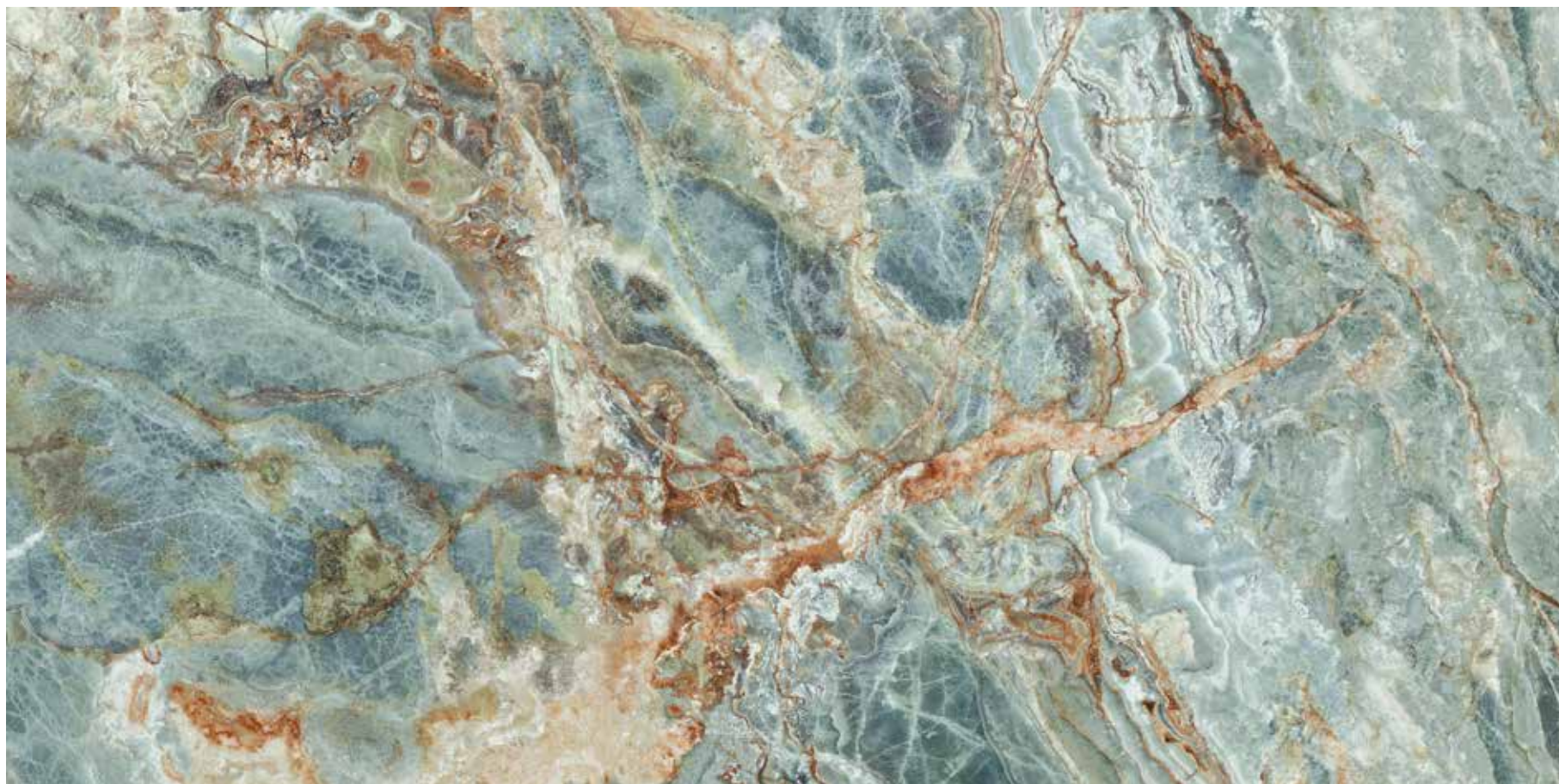

12 MM $\frac{1}{2}$

MAT / MATT

88000195	Mat / Matt	12 mm	163 x 323 cm	Osso Mat 12 mm / Osso Matt 12 mm
88000195R	Mat / Matt	12 mm	160 x 320 cm	Osso Mat 2 mm Rektifiye / Osso Matt 12 mm Rectified

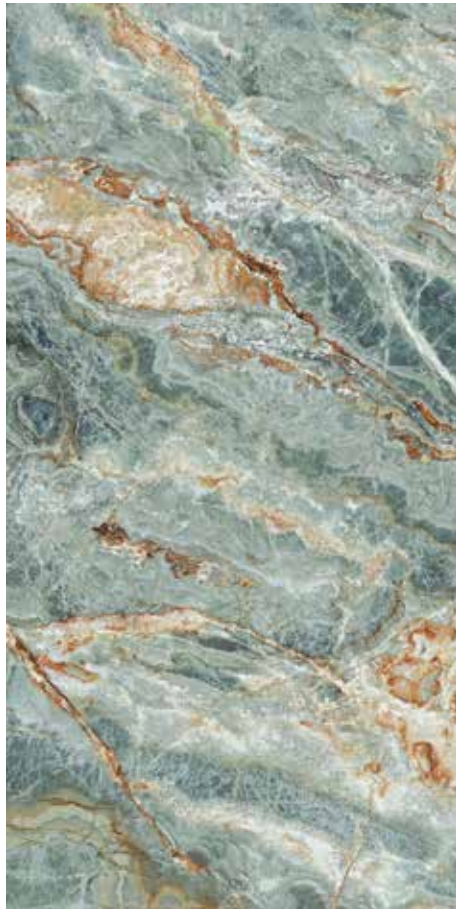

6 MM $\frac{\downarrow}{\uparrow}$

MAT / MATT

88000196
88000196R

Mat / Matt
Mat / Matt

6 mm
6 mm

163 x 323 cm
160 x 320 cm

Osso Mat 6 mm / Osso Matt 6 mm
Osso Mat 6 mm Rektifiye / Osso Matt 6 mm Rectified

OSSO

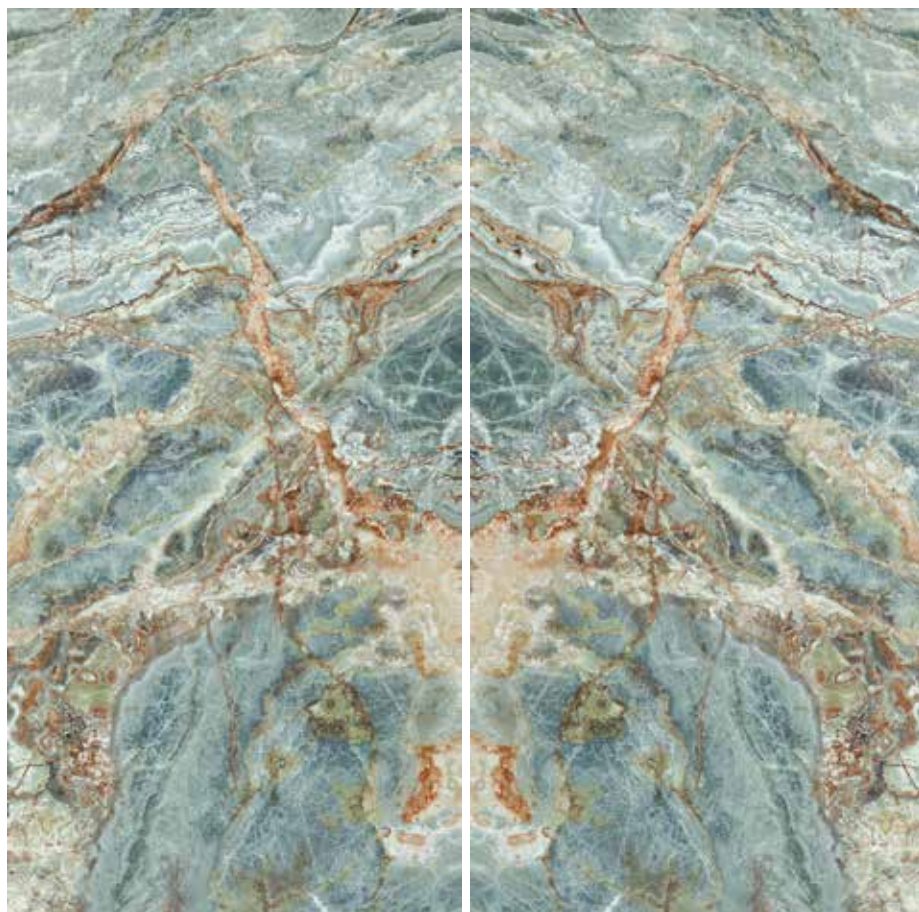

12 MM $\frac{\downarrow}{\uparrow}$

6 MM $\frac{\downarrow}{\uparrow}$

MAT / MATT

88000131	Mat / Matt	12 mm	163 x 323 cm	Osso Mat Bookmatch 12 mm / Osso Matt Bookmatch 12 mm
88000131R	Mat / Matt	12 mm	160 x 320 cm	Osso Mat Bookmatch 12 mm Rektifiye / Osso Matt Bookmatch 12 mm Rectified
88000132	Mat / Matt	6 mm	163 x 323 cm	Osso Mat Bookmatch 6 mm / Osso Matt Bookmatch 6 mm
88000132R	Mat / Matt	6 mm	160 x 320 cm	Osso Mat Bookmatch 6 mm Rektifiye / Osso Matt Bookmatch 6 mm Rectified



NG | STONE
PORCELAIN SLABS

PANDA WHITE





PANDA WHITE



12 MM $\frac{1}{2}$

PARLAK / GLOSSY

88000139P	Parlak / Glossy	12 mm	163 x 323 cm	Panda White Parlak 12 mm / Panda White Glossy 12 mm
88000139RP	Parlak / Glossy	12 mm	160 x 320 cm	Panda White Parlak 12 mm Rektifiye / Panda White Glossy 12 mm Rectified



12 MM $\frac{\downarrow}{\uparrow}$	6 MM $\frac{\downarrow}{\uparrow}$	PARLAK / GLOSSY	SATINATO
--	---	------------------------	-----------------

88000137P	Parlak / Glossy	12 mm	163 x 323 cm	Panda White Parlak Bookmatch 12 mm / Panda White Glossy Bookmatch 12 mm
88000137RP	Parlak / Glossy	12 mm	160 x 320 cm	Panda White Parlak Bookmatch 12 mm Rektifiye / Panda White Glossy Bookmatch 12 mm Rectified
88000137S	Satinato / Sat.	12 mm	163 x 323 cm	Panda White Satinato Bookmatch 12 mm / Panda White Satinato Bookmatch 12 mm
88000137RS	Satinato / Sat.	12 mm	160 x 320 cm	Panda White Satinato Bookmatch 12 mm Rektifiye / Panda White Satinato Bookmatch 12 mm Rectified
88000138P	Parlak / Glossy	6 mm	163 x 323 cm	Panda White Parlak Bookmatch 6 mm / Panda White Glossy Bookmatch 6 mm
88000138RP	Parlak / Glossy	6 mm	160 x 320 cm	Panda White Parlak Bookmatch 6 mm Rektifiye / Panda White Glossy Bookmatch 6 mm Rectified
88000138S	Satinato / Sat.	6 mm	163 x 323 cm	Panda White Satinato Bookmatch 6 mm / Panda White Satinato Bookmatch 6 mm
88000138RS	Satinato / Sat.	6 mm	160 x 320 cm	Panda White Satinato Bookmatch 6 mm Rektifiye / Panda White Satinato Bookmatch 6 mm Rectified

PANDA WHITE



12 MM $\frac{1}{2}$

PARLAK / GLOSSY

SATINATO

88000188ABP
88000188ABS

Parlak / Glossy
Satinato / Sat.

12 mm
12 mm

83 x 323 cm
83 x 323 cm

Panda White Parlak AB 12 mm / Panda White Glossy AB 12 mm
Panda White Satinato AB 12 mm / Panda White Satinato AB 12 mm



NG | STONE
PORCELAIN SLABS

PIETRA



12 MM $\frac{1}{2}$

PARLAK / GLOSSY

MAT / MATT

88000042P	Parlak / Glossy	12 mm	163 x 323 cm	Pietra Gri Parlak 12 mm / Pietra Grey Glossy 12 mm
88000042RP	Parlak / Glossy	12 mm	160 x 320 cm	Pietra Gri Parlak 12 mm Rektifiye / Pietra Grey Glossy 12 mm Rectified
88000042	Mat / Matt	12 mm	163 x 323 cm	Pietra Gri Mat 12 mm / Pietra Grey Matt 12 mm
88000042R	Mat / Matt	12 mm	160 x 320 cm	Pietra Gri Mat 12 mm Rektifiye / Pietra Grey Matt 12 mm Rectified



6 MM $\frac{\downarrow}{\uparrow}$

PARLAK / GLOSSY

MAT / MATT

88000043P	Parlak / Glossy	6 mm	163 x 323 cm	Pietra Gri Parlak 6 mm / Pietra Grey Glossy 6 mm
88000043RP	Parlak / Glossy	6 mm	160 x 320 cm	Pietra Gri Parlak 6 mm Rektifiye / Pietra Grey Glossy 6 mm Rectified
88000043	Mat / Matt	6 mm	163 x 323 cm	Pietra Gri Mat 6 mm / Pietra Grey Matt 6 mm
88000043R	Mat / Matt	6 mm	160 x 320 cm	Pietra Gri Mat 6 mm Rektifiye / Pietra Grey Matt 6 mm Rectified

PIETRA



12 MM $\frac{\updownarrow}{\updownarrow}$

PARLAK / GLOSSY

MAT / MATT

88000160ABP	Parlak / Glossy	12 mm	83 x 323 cm	Pietra Gri Parlak AB 12 mm / Pietra Grey Glossy AB 12 mm
88000160AB	Mat / Matt	12 mm	83 x 323 cm	Pietra Gri Mat AB 12 mm / Pietra Grey Matt AB 12 mm



NG | STONE
PORCELAIN SLABS

PULPIS CHOCOLATE

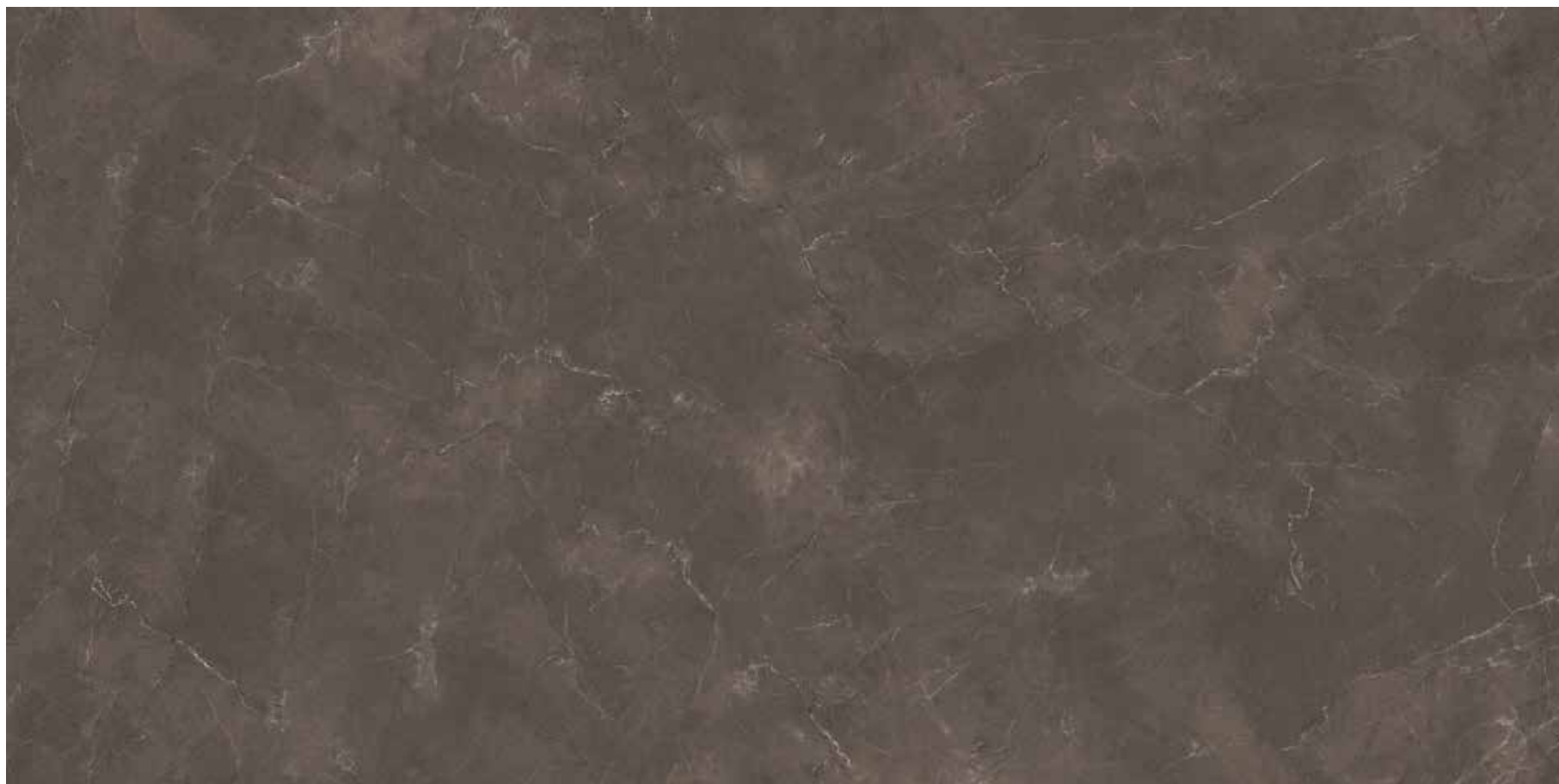

12 MM $\frac{1}{2}$

MAT / MATT

88000141	Mat / Matt	12 mm	163 x 323 cm	Pulpis Chocolate Mat 12 mm / Pulpis Chocolate Matt 12 mm
88000141R	Mat / Matt	12 mm	160 x 320 cm	Pulpis Chocolate Mat 12 mm Rektifiye / Pulpis Chocolate Matt 12 mm Rectified



6 MM $\frac{\downarrow}{\uparrow}$

MAT / MATT

88000198	Mat / Matt	6 mm	163 x 323 cm	Pulpis Chocolate Mat 6 mm / Pulpis Chocolate Matt 6 mm
88000198R	Mat / Matt	6 mm	160 x 320 cm	Pulpis Chocolate Mat 6 mm Rektifiye / Pulpis Chocolate Matt 6 mm Rectified

PULPIS CHOCOLATE



12 MM $\frac{\updownarrow}{\updownarrow}$

MAT / MATT

88000199 | Mat / Matt | 12 mm | 83 x 323 cm | Pulpis Chocolate Mat 12 mm / Pulpis Chocolate Matt 12 mm



NG | STONE
PORCELAIN SLABS

RAPSODY



12 MM $\frac{1}{2}$

PARLAK / GLOSSY

SATINATO

MAT / MATT

88000026P	Parlak / Glossy	12 mm	163 x 323 cm	Rapsody Gri Parlak 12 mm / Rapsody Grey Glossy 12 mm
88000026RP	Parlak / Glossy	12 mm	160 x 320 cm	Rapsody Gri Parlak 12 mm Rektifiye / Rapsody Grey Glossy 12 mm Rectified
88000026S	Satinato / Sat.	12 mm	163 x 323 cm	Rapsody Gri Satinato 12 mm / Rapsody Grey Satinato 12 mm
88000026RS	Satinato / Sat.	12 mm	160 x 320 cm	Rapsody Gri Satinato 12 mm Rektifiye / Rapsody Grey Satinato 12 mm Rectified
88000026	Mat / Matt	12 mm	163 x 323 cm	Rapsody Gri Mat 12 mm / Rapsody Grey Matt 12 mm
88000026R	Mat / Matt	12 mm	160 x 320 cm	Rapsody Gri Mat 12 mm Rektifiye / Rapsody Grey Matt 12 mm Rectified



6 MM $\frac{\downarrow}{\uparrow}$	PARLAK / GLOSSY	SATINATO	MAT / MATT
---	------------------------	-----------------	-------------------

88000027P	Parlak / Glossy	6 mm	163 x 323 cm	Rapsody Gri Parlak 6 mm / Rapsody Grey Glossy 6 mm
88000027RP	Parlak / Glossy	6 mm	160 x 320 cm	Rapsody Gri Parlak 6 mm Rektifiye / Rapsody Grey Glossy 6 mm Rectified
88000027S	Satinato / Sat.	6 mm	163 x 323 cm	Rapsody Gri Satinato 6 mm / Rapsody Grey Satinato 6 mm
88000027RS	Satinato / Sat.	6 mm	160 x 320 cm	Rapsody Gri Satinato 6 mm Rektifiye / Rapsody Grey Satinato 6 mm Rectified
88000027	Mat / Matt	6 mm	163 x 323 cm	Rapsody Gri Mat 6 mm / Rapsody Grey Matt 6 mm
88000027R	Mat / Matt	6 mm	160 x 320 cm	Rapsody Gri Mat 6 mm Rektifiye / Rapsody Grey Matt 6 mm Rectified

RAPSODY



12 MM $\frac{\updownarrow}{\updownarrow}$

PARLAK / GLOSSY

SATINATO

MAT / MATT

88000153ABP	Parlak / Glossy	12 mm	83 x 323 cm	Rapsody Gri Parlak AB 12 mm / Rapsody Grey Glossy AB 12 mm
88000153ABS	Satinato / Sat.	12 mm	83 x 323 cm	Rapsody Gri Satinato AB 12 mm / Rapsody Grey Satinato AB 12 mm
88000153AB	Mat / Matt	12 mm	83 x 323 cm	Rapsody Gri Mat AB 12 mm / Rapsody Grey Matt AB 12 mm



NG | STONE
PORCELAIN SLABS

SAGA

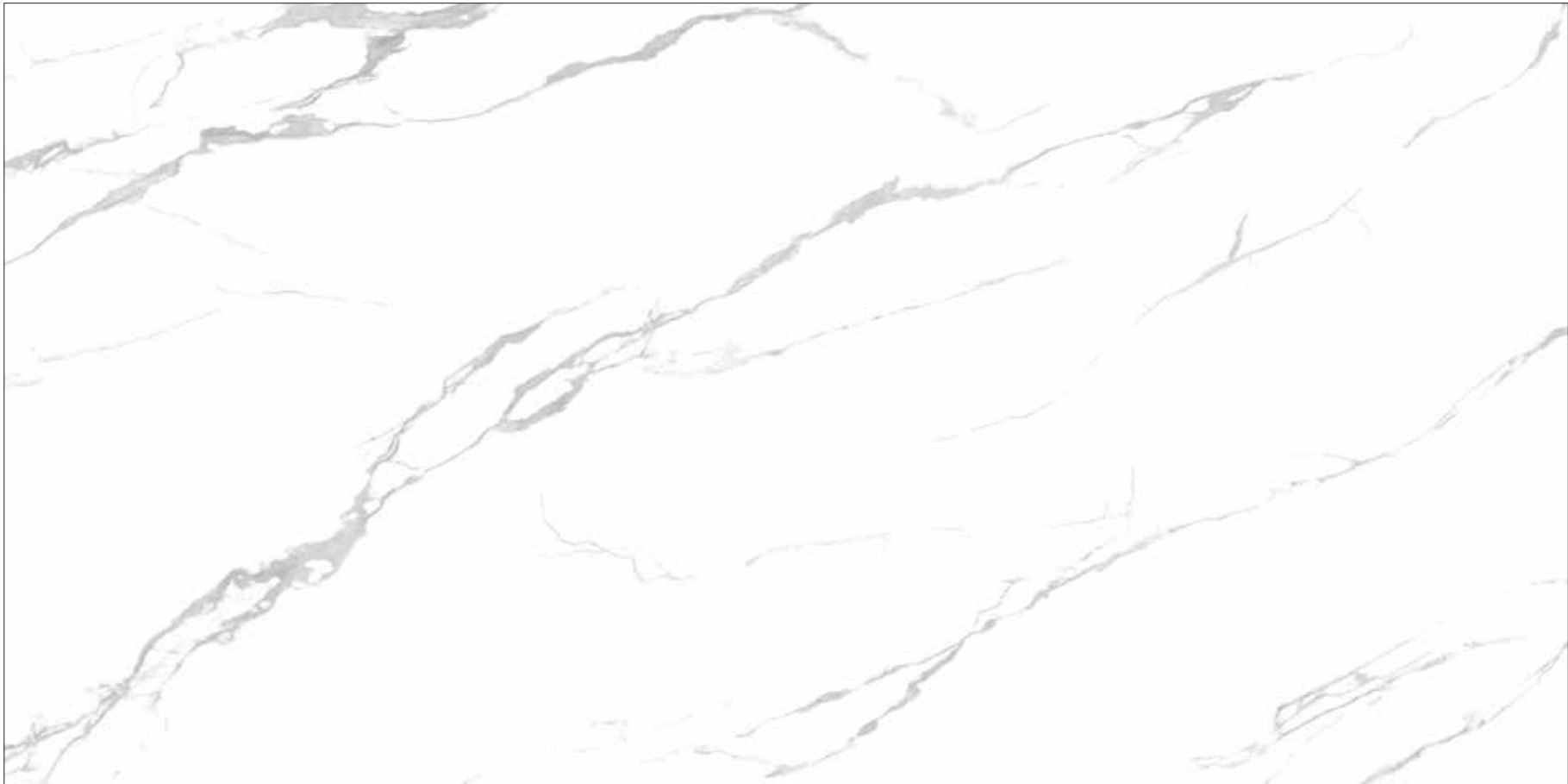

12 MM $\frac{1}{2}$

PARLAK / GLOSSY

SATINATO

SOFT MAT / SOFT MATT

88000080P	Parlak / Glossy	12 mm	163 x 323 cm	Saga Parlak 12 mm / Saga Glossy 12 mm
88000080RP	Parlak / Glossy	12 mm	160 x 320 cm	Saga Parlak 12 mm Rektifiye / Saga Glossy 12 mm Rectified
88000080S	Satinato / Sat.	12 mm	163 x 323 cm	Saga Satinato 12 mm / Saga Satinato 12 mm
88000080RS	Satinato / Sat.	12 mm	160 x 320 cm	Saga Satinato 12 mm Rektifiye / Saga Satinato 12 mm Rectified
88000080	Soft Mat / So. M.	12 mm	163 x 323 cm	Saga Soft Mat 12 mm / Saga Soft Matt 12 mm
88000080R	Soft Mat / So. M.	12 mm	160 x 320 cm	Saga Soft Mat 12 mm Rektifiye / Saga Soft Matt 12 mm Rectified

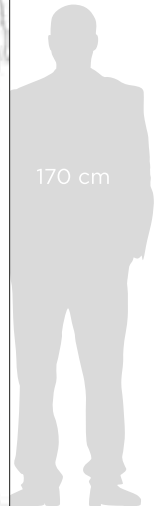

6 MM $\frac{\downarrow}{\uparrow}$

PARLAK / GLOSSY

SATINATO

SOFT MAT / SOFT MATT

88000079P	Parlak / Glossy	6 mm	163 x 323 cm	Saga Parlak 6 mm / Saga Glossy 6 mm
88000079RP	Parlak / Glossy	6 mm	160 x 320 cm	Saga Parlak 6 mm Rektifiye / Saga Glossy 6 mm Rectified
88000079S	Satinato / Sat.	6 mm	163 x 323 cm	Saga Satinato 6 mm / Saga Satinato 6 mm
88000079RS	Satinato / Sat.	6 mm	160 x 320 cm	Saga Satinato 6 mm Rektifiye / Saga Satinato 6 mm Rectified
88000079	Soft Mat / So. M.	6 mm	163 x 323 cm	Saga Soft Mat 6 mm / Saga Soft Matt 6 mm
88000079R	Soft Mat / So. M.	6 mm	160 x 320 cm	Saga Soft Mat 6 mm Rektifiye / Saga Soft Matt 6 mm Rectified

SAGA



12 MM $\frac{\updownarrow}{\updownarrow}$

PARLAK / GLOSSY

SATINATO

SOFT MAT / SOFT MATT

88000172ABP	Parlak / Glossy	12 mm	83 x 323 cm	Saga Parlak AB 12 mm / Saga Glossy AB 12 mm
88000172ABS	Satinato / Sat.	12 mm	83 x 323 cm	Saga Satinato AB 12 mm / Saga Satinato AB 12 mm
88000172AB	Soft Mat / So. M.	12 mm	83 x 323 cm	Saga Soft Mat AB 12 mm / Saga Soft Matt AB 12 mm



NG | STONE
PORCELAIN SLABS

SIERRA



12 MM $\frac{1}{2}$

PARLAK / GLOSSY

MAT / MATT

88000179P	Parlak / Glossy	12 mm	163 x 323 cm	Sierra Vizon Parlak 12 mm / Sierra Mink Glossy 12 mm
88000179RP	Parlak / Glossy	12 mm	160 x 320 cm	Sierra Vizon Parlak 12 mm Rektifiye / Sierra Mink Glossy 12 mm Rectified
88000179	Mat / Matt	12 mm	163 x 323 cm	Sierra Vizon Mat 12 mm / Sierra Mink Matt 12 mm
88000179R	Mat / Matt	12 mm	160 x 320 cm	Sierra Vizon Mat 12 mm Rektifiye / Sierra Mink Matt 12 mm Rectified

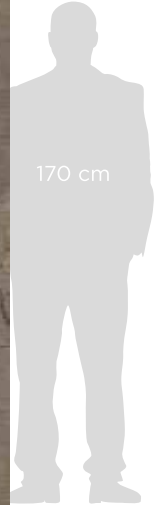

6 MM $\frac{\downarrow}{\uparrow}$ **PARLAK / GLOSSY** **MAT / MATT**

88000180P	Parlak / Glossy	6 mm	163 x 323 cm	Sierra Vizon Parlak 6 mm / Sierra Mink Glossy 6 mm
88000180RP	Parlak / Glossy	6 mm	160 x 320 cm	Sierra Vizon Parlak 6 mm Rektifiye / Sierra Mink Glossy 6 mm Rectified
88000180	Mat / Matt	6 mm	163 x 323 cm	Sierra Vizon Mat 6 mm / Sierra Mink Matt 6 mm
88000180R	Mat / Matt	6 mm	160 x 320 cm	Sierra Vizon Mat 6 mm Rektifiye / Sierra Mink Matt 6 mm Rectified

SIERRA



12 MM $\frac{1}{2}$

PARLAK / GLOSSY

MAT / MATT

88000182ABP
88000182AB

Parlak / Glossy
Mat / Matt

12 mm
12 mm

83 x 323 cm
83 x 323 cm

Sierra Vizon Parlak AB 12 mm / Sierra Mink Glossy AB 12 mm
Sierra Vizon Mat AB 12 mm / Sierra Mink Matt AB 12 mm

The background of the entire image is a high-resolution, close-up view of a marbled porcelain slab. The pattern is complex and organic, featuring a base color of dark charcoal grey. Overlaid on this are numerous veins and blotches in shades of light grey, off-white, and a subtle, earthy brown. The veins vary in thickness and orientation, some running horizontally across the frame, others curving or branching out. The overall effect is one of natural, stone-like texture and depth.

NG | STONE
PORCELAIN SLABS

STATUARIO FLASH





STATUARIO FLASH



12 MM

PARLAK / GLOSSY

SATINATO

SOFT MAT / SOFT MATT

88000058P	Parlak / Glossy	12 mm	163 x 323 cm	Statuario Flash Parlak 12 mm / Statuario Flash Glossy 12 mm
88000058RP	Parlak / Glossy	12 mm	160 x 320 cm	Statuario Flash Parlak 12 mm Rektifiye / Statuario Flash Glossy 12 mm Rectified
88000058S	Satinato / Sat.	12 mm	163 x 323 cm	Statuario Flash Satinato 12 mm / Statuario Flash Satinato 12 mm
88000058RS	Satinato / Sat.	12 mm	160 x 320 cm	Statuario Flash Satinato 12 mm Rektifiye / Statuario Flash Satinato 12 mm Rectified
88000058	Soft Mat / So. M.	12 mm	163 x 323 cm	Statuario Flash Soft Mat 12 mm / Statuario Flash Soft Matt 12 mm
88000058R	Soft Mat / So. M.	12 mm	160 x 320 cm	Statuario Flash Soft Mat 12 mm Rektifiye / Statuario Flash Soft Matt 12 mm Rectified



6 MM	PARLAK / GLOSSY	SATINATO	SOFT MAT / SOFT MATT
------	-----------------	----------	----------------------

88000059P	Parlak / Glossy	6 mm	163 x 323 cm	Statuario Flash Parlak 6 mm / Statuario Flash Glossy 6 mm
88000059RP	Parlak / Glossy	6 mm	160 x 320 cm	Statuario Flash Parlak 6 mm Rektifiye / Statuario Flash Glossy 6 mm Rectified
88000059RS	Satinato / Sat.	6 mm	160 x 320 cm	Statuario Flash Satinato 6 mm Rektifiye / Statuario Flash Satinato 6 mm Rectified
88000059S	Satinato / Sat.	6 mm	163 x 323 cm	Statuario Flash Satinato 6 mm / Statuario Flash Satinato 6 mm
88000059	Soft Mat / So. M.	6 mm	163 x 323 cm	Statuario Flash Soft Mat 6 mm / Statuario Flash Soft Matt 6 mm
88000059R	Soft Mat / So. M.	6 mm	160 x 320 cm	Statuario Flash Soft Mat 6 mm Rektifiye / Statuario Flash Soft Matt 6 mm Rectified

STATUARIO FLASH



12 MM

6 MM

PARLAK / GLOSSY

SATINATO

SOFT MAT / SOFT MATT

88000133P	Parlak / Glossy	12 mm	163 x 323 cm	Statuario Flash Parlak Bookmatch 12 mm / Statuario Flash Glossy Bookmatch 12 mm
88000133RP	Parlak / Glossy	12 mm	160 x 320 cm	Statuario Flash Parlak Bookmatch 12 mm Rektifiye / Statuario Flash Glossy Bookmatch 12 mm Rectified
88000133S	Satinato / Sat.	12 mm	163 x 323 cm	Statuario Flash Satinato Bookmatch 12 mm / Statuario Flash Satinato Bookmatch 12 mm
88000133RS	Satinato / Sat.	12 mm	160 x 320 cm	Statuario Flash Satinato Bookmatch 12 mm Rektifiye / Statuario Flash Satinato Bookmatch 12 mm Rectified
88000133	Soft Mat / So. M.	12 mm	163 x 323 cm	Statuario Flash Soft Mat Bookmatch 12 mm / Statuario Flash Soft Matt Bookmatch 12 mm
88000133R	Soft Mat / So. M.	12 mm	160 x 320 cm	Statuario Flash Soft Mat Bookmatch 12 mm Rektifiye / Statuario Flash Soft Matt Bookmatch 12 mm Rectified
88000134P	Parlak / Glossy	6 mm	163 x 323 cm	Statuario Flash Parlak Bookmatch 6 mm / Statuario Flash Glossy Bookmatch 6 mm
88000134RP	Parlak / Glossy	6 mm	160 x 320 cm	Statuario Flash Parlak Bookmatch 6 mm Rektifiye / Statuario Flash Glossy Bookmatch 6 mm Rectified
88000134S	Satinato / Sat.	6 mm	163 x 323 cm	Statuario Flash Satinato Bookmatch 6 mm / Statuario Flash Satinato Bookmatch 6 mm
88000134RS	Satinato / Sat.	6 mm	160 x 320 cm	Statuario Flash Satinato Bookmatch 6 mm Rektifiye / Statuario Flash Satinato Bookmatch 6 mm Rectified
88000134	Soft Mat / So. M.	6 mm	163 x 323 cm	Statuario Flash Soft Mat Bookmatch 6 mm / Statuario Flash Soft Matt Bookmatch 6 mm
88000134R	Soft Mat / So. M.	6 mm	160 x 320 cm	Statuario Flash Soft Mat Bookmatch 6 mm Rektifiye / Statuario Flash Soft Matt Bookmatch 6 mm Rectified



12 MM

PARLAK / GLOSSY

SATINATO

SOFT MAT / SOFT MATT

88000177ABP	Parlak / Glossy	12 mm	83 x 323 cm	Statuario Flash Parlak AB 12 mm / Statuario Flash Glossy AB 12 mm
88000166ABS	Satinato / Sat.	12 mm	83 x 323 cm	Statuario Flash Satinato AB 12 mm / Statuario Flash Satinato AB 12 mm
88000166AB	Soft Mat / So. M.	12 mm	83 x 323 cm	Statuario Flash Soft Mat AB 12 mm / Statuario Flash Soft Matt AB 12 mm

TRAVERTINE





TRAVERTINE



12 MM

MAT / MATT

88000068	Mat / Matt	12 mm	163 x 323 cm	Travertine Fildişi Mat 12 mm / Travertine Ivory Matt 12 mm
88000060R	Mat / Matt	12 mm	160 x 320 cm	Travertine Fildişi Mat 12 mm Rektifiye / Travertine Ivory Matt 12 mm Rectified



6 MM | **MAT / MATT**

88000061	Mat / Matt	6 mm	163 x 323 cm	Travertine Fildişi Mat 6 mm / Travertine Ivory Matt 6 mm
88000061R	Mat / Matt	6 mm	160 x 320 cm	Travertine Fildişi Mat 6 mm Rektifiye / Travertine Ivory Matt 6 mm Rectified

TRAVERTINE



12 MM

MAT / MATT

88000114 | Mat / Matt | 12 mm | 83 x 323 cm | Travertine Fildişi Mat 12 mm / Travertine Ivory Matt 12 mm

NG | STONE
PORCELAIN SLABS

VALERIA





VALERIA



12 MM

PARLAK / GLOSSY

SATINATO

SOFT MAT / SOFT MATT

88000077P	Parlak / Glossy	12 mm	163 x 323 cm	Valeria Parlak 12 mm / Valeria Glossy 12 mm
88000077RP	Parlak / Glossy	12 mm	160 x 320 cm	Valeria Parlak 12 mm Rektifiye / Valeria Glossy 12 mm Rectified
88000077S	Satinato / Sat.	12 mm	163 x 323 cm	Valeria Satinato 12 mm / Valeria Satinato 12 mm
88000077	Soft Mat / So. M.	12 mm	163 x 323 cm	Valeria Soft Mat 12 mm / Valeria Soft Matt 12 mm
88000077R	Soft Mat / So. M.	12 mm	160 x 320 cm	Valeria Soft Mat 12 mm Rektifiye / Valeria Soft Matt 12 mm Rectified



6 MM	PARLAK / GLOSSY	SOFT MAT / SOFT MATT
-------------	------------------------	-----------------------------

88000078P	Parlak / Glossy	6 mm	163 x 323 cm	Valeria Parlak 6 mm / Valeria Glossy 6 mm
88000078RP	Parlak / Glossy	6 mm	160 x 320 cm	Valeria Parlak 6 mm Rektifiye / Valeria Glossy 6 mm Rectified
88000078	Soft Mat / So. M.	6 mm	163 x 323 cm	Valeria Soft Mat 6 mm / Valeria Soft Matt 6 mm
88000078R	Soft Mat / So. M.	6 mm	160 x 320 cm	Valeria Soft Mat 6 mm Rektifiye / Valeria Soft Matt 6 mm Rectified

VALERIA



12 MM

6 MM

PARLAK / GLOSSY

SOFT MAT / SOFT MATT

88000135P	Parlak / Glossy	12 mm	163 x 323 cm	Valeria Parlak Bookmatch 12 mm / Valeria Glossy Bookmatch 12 mm
88000135RP	Parlak / Glossy	12 mm	160 x 320 cm	Valeria Parlak Bookmatch 12 mm Rektifiye / Valeria Glossy Bookmatch 12 mm Rectified
88000004	Soft Mat / So. M.	12 mm	163 x 323 cm	Valeria Soft Mat Bookmatch 12 mm / Valeria Soft Matt Bookmatch 12 mm
88000135R	Soft Mat / So. M.	12 mm	160 x 320 cm	Valeria Soft Mat Bookmatch 12 mm Rektifiye / Valeria Soft Matt Bookmatch 12 mm Rectified
88000136P	Parlak / Glossy	6 mm	163 x 323 cm	Valeria Parlak Bookmatch 6 mm / Valeria Glossy Bookmatch 6 mm
88000136RP	Parlak / Glossy	6 mm	160 x 320 cm	Valeria Parlak Bookmatch 6 mm Rektifiye / Valeria Glossy Bookmatch 6 mm Rectified
88000136	Soft Mat / So. M.	6 mm	163 x 323 cm	Valeria Soft Mat Bookmatch 6 mm / Valeria Soft Matt Bookmatch 6 mm
88000136R	Soft Mat / So. M.	6 mm	160 x 320 cm	Valeria Soft Mat Bookmatch 6 mm Rektifiye / Valeria Soft Matt Bookmatch 6 mm Rectified



12 MM

PARLAK / GLOSSY

SOFT MAT / SOFT MATT

88000171ABP	Parlak / Glossy	12 mm	83 x 323 cm	Valeria Parlak AB 12 mm / Valeria Glossy AB 12 mm
88000171AB	Soft Mat / So. M.	12 mm	83 x 323 cm	Valeria Soft Mat AB 12 mm / Valeria Soft Matt AB 12 mm

WHITE FOREST



12 MM

PARLAK / GLOSSY

SATINATO

MAT / MATT

88000066P	Parlak / Glossy	12 mm	163 x 323 cm	White Forest Parlak 12 mm / White Forest Glossy 12 mm
88000066RP	Parlak / Glossy	12 mm	160 x 320 cm	White Forest Parlak 12 mm Rektifiye / White Forest Glossy 12 mm Rectified
88000066S	Satinato / Sat.	12 mm	163 x 323 cm	White Forest Satinato 12 mm / White Forest Satinato 12 mm
88000066RS	Satinato / Sat.	12 mm	160 x 320 cm	White Forest Satinato 12 mm Rektifiye / White Forest Satinato 12 mm Rectified
88000066	Mat / Matt	12 mm	163 x 323 cm	White Forest Mat 12 mm / White Forest Matt 12 mm
88000066R	Mat / Matt	12 mm	160 x 320 cm	White Forest Mat 12 mm Rektifiye / White Forest Matt 12 mm Rectified



6 MM	PARLAK / GLOSSY	SATINATO	MAT / MATT
-------------	------------------------	-----------------	-------------------

88000067P	Parlak / Glossy	6 mm	163 x 323 cm	White Forest Parlak 6 mm / White Forest Glossy 6 mm
88000067RP	Parlak / Glossy	6 mm	160 x 320 cm	White Forest Parlak 6 mm Rektifiye / White Forest Glossy 6 mm Rectified
88000067S	Satinato / Sat.	6 mm	163 x 323 cm	White Forest Satinato 6 mm / White Forest Satinato 6 mm
88000067RS	Satinato / Sat.	6 mm	160 x 320 cm	White Forest Satinato 6 mm Rektifiye / White Forest Satinato 6 mm Rectified
88000067	Mat / Matt	6 mm	163 x 323 cm	White Forest Mat 6 mm / White Forest Matt 6 mm
88000067R	Mat / Matt	6 mm	160 x 320 cm	White Forest Mat 6 mm Rektifiye / White Forest Matt 6 mm Rectified

WHITE FOREST



12 MM

PARLAK / GLOSSY

SATINATO

MAT / MATT

88000169ABP	Parlak / Glossy	12 mm	83 x 323 cm	White Forest Parlak AB 12 mm / White Forest Glossy AB 12 mm
88000169ABS	Satinato / Sat.	12 mm	83 x 323 cm	White Forest Satinato AB 12 mm / White Forest Satinato AB 12 mm
88000169AB	Mat / Matt	12 mm	83 x 323 cm	White Forest Mat AB 12 mm / White Forest Matt AB 12 mm

The background of the image is a close-up of a light-colored, marbled porcelain slab. The pattern consists of soft, wavy veins of slightly darker shades of beige and cream, creating a natural stone-like appearance. The overall tone is warm and neutral.

NG | **STONE**
PORCELAIN SLABS

ARUNA

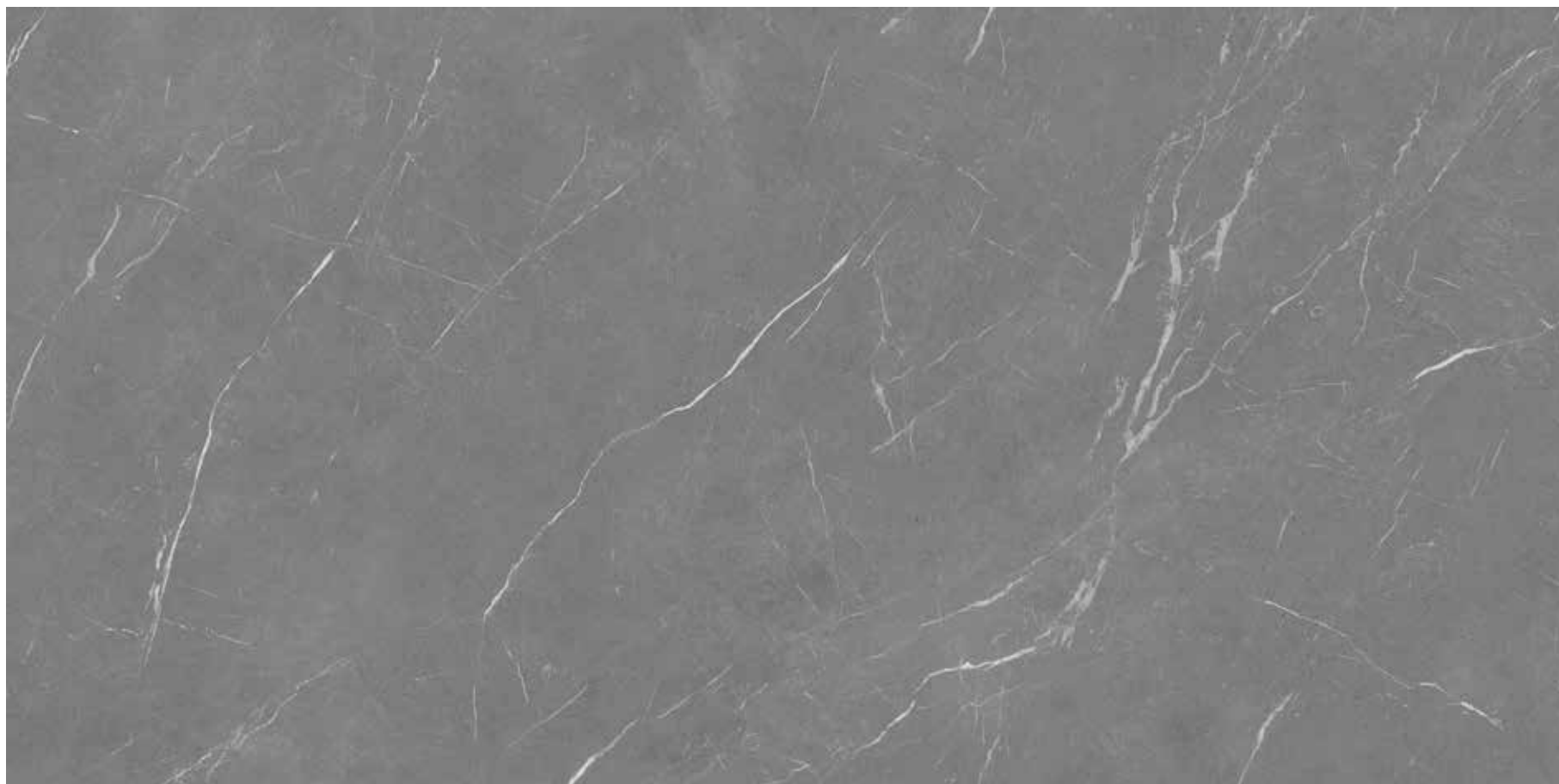

12 MM

MAT / MATT

88000201	Mat / Matt	12 mm	163 x 323 cm	Aruna Gri Mat 12 mm / Aruna Grey Matt 12 mm
88000201R	Mat / Matt	12 mm	160 x 320 cm	Aruna Gri Mat 12 mm Rektifiye / Aruna Grey Matt 12 mm Rectified

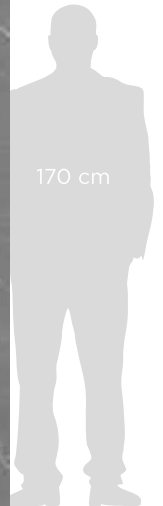
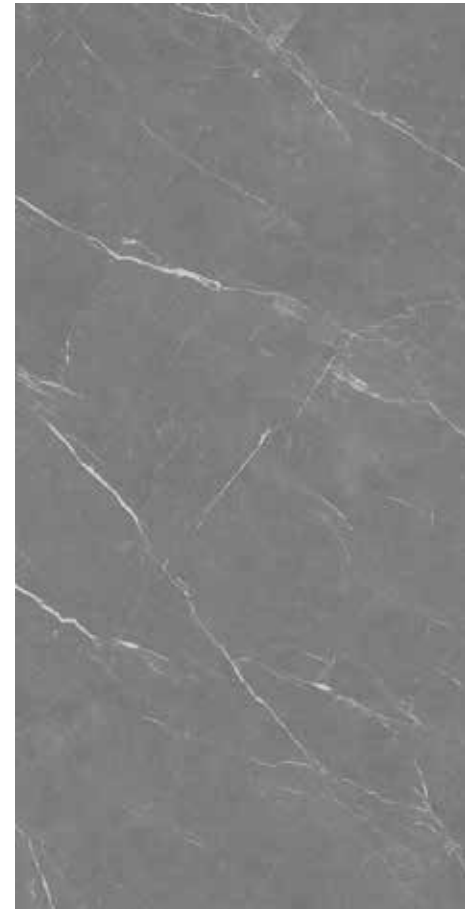
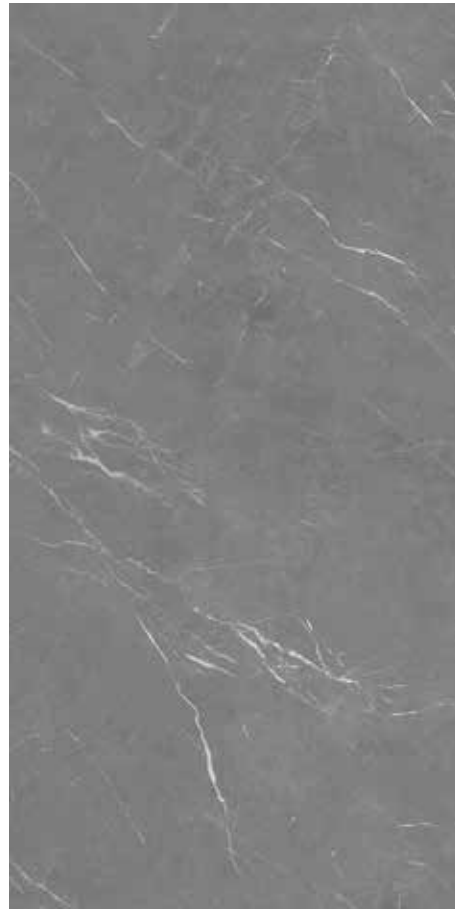

6 MM | **MAT / MATT**

88000201	Mat / Matt	6 mm	163 x 323 cm	Aruna Gri Mat 6 mm / Aruna Grey Mat Matt 6 mm
88000201R	Mat / Matt	6 mm	160 x 320 cm	Aruna Gri Mat 6 mm Rektifiye / Aruna Grey Matt 6 mm Rectified

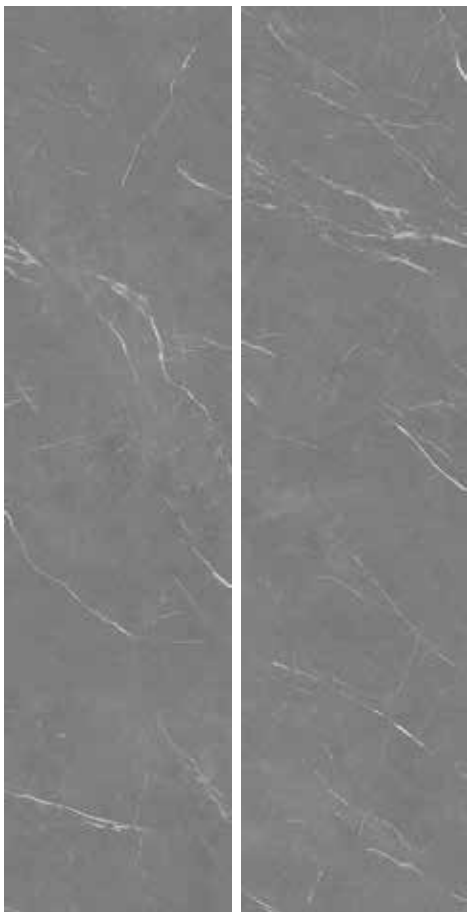

12 MM

MAT / MATT

88000206AB | Mat / Matt | 12 mm | 83 x 323 cm | Aruna Gri Mat AB 12 mm / Aruna Grey Matt AB 12 mm



NG | STONE
PORCELAIN SLABS

CALACATTA OREO



12 MM

PARLAK / GLOSSY

SATINATO

MAT / MATT

88000018P	Parlak / Glossy	12 mm	163 x 323 cm	Calacatta Oreo Parlak 12 mm / Calacatta Oreo Glossy 12 mm
88000018RP	Parlak / Glossy	12 mm	160 x 320 cm	Calacatta Oreo Parlak 12 mm Rektifiye / Calacatta Oreo Glossy 12 mm Rectified
88000018S	Satinato / Sat.	12 mm	163 x 323 cm	Calacatta Oreo Satinato 12 mm / Calacatta Oreo Satinato 12 mm
88000018RS	Satinato / Sat.	12 mm	160 x 320 cm	Calacatta Oreo Satinato 12 mm Rektifiye / Calacatta Oreo Satinato 12 mm Rectified
88000018	Mat / Matt	12 mm	163 x 323 cm	Calacatta Oreo Mat 12 mm / Calacatta Oreo Matt 12 mm
88000018R	Mat / Matt	12 mm	160 x 320 cm	Calacatta Oreo Mat 12 mm Rektifiye / Calacatta Oreo Matt 12 mm Rectified



6 MM	PARLAK / GLOSSY	SATINATO	MAT / MATT
-------------	------------------------	-----------------	-------------------

88000019P	Parlak / Glossy	6 mm	163 x 323 cm	Calacatta Oreo Parlak 6 mm / Calacatta Oreo Glossy 6 mm
88000019RP	Parlak / Glossy	6 mm	160 x 320 cm	Calacatta Oreo Parlak 6 mm Rektifiye / Calacatta Oreo Glossy 6 mm Rectified
88000019S	Satinato / Sat.	6 mm	163 x 323 cm	Calacatta Oreo Satinato 6 mm / Calacatta Oreo Satinato 6 mm
88000019RS	Satinato / Sat.	6 mm	160 x 320 cm	Calacatta Oreo Satinato 6 mm Rektifiye / Calacatta Oreo Satinato 6 mm Rectified
88000019	Mat / Matt	6 mm	163 x 323 cm	Calacatta Oreo Mat 6 mm / Calacatta Oreo Matt 6 mm
88000019R	Mat / Matt	6 mm	160 x 320 cm	Calacatta Oreo Mat 6 mm Rektifiye / Calacatta Oreo Matt 6 mm Rectified

CALACATTA OREO

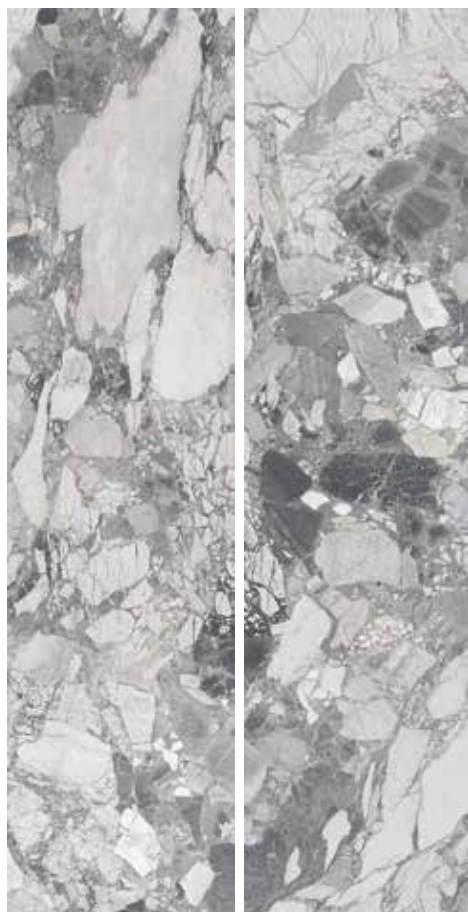

12 MM

PARLAK / GLOSSY

SATINATO

MAT / MATT

88000149ABP	Parlak / Glossy	12 mm	83 x 323 cm	Calacatta Oreo Parlak AB 12 mm / Calacatta Oreo Glossy AB 12 mm
88000149ABS	Satinato / Sat.	12 mm	83 x 323 cm	Calacatta Oreo Satinato AB 12 mm / Calacatta Oreo Satinato AB 12 mm
88000149AB	Mat / Matt	12 mm	83 x 323 cm	Calacatta Oreo Mat AB 12 mm / Calacatta Oreo Matt AB 12 mm



NG | STONE
PORCELAIN SLABS

COSMIC SILVER



12 MM

PARLAK / GLOSSY

88000183P	Parlak / Glossy	12 mm	163 x 323 cm	Cosmic Silver Parlak 12 mm / Cosmic Silver Glossy 12 mm
88000183RP	Parlak / Glossy	12 mm	160 x 320 cm	Cosmic Silver Parlak 12 mm Rektifiye / Cosmic Silver Glossy 12 mm Rectified



6 MM

PARLAK / GLOSSY

88000184P
88000184RP

Parlak / Glossy
Parlak / Glossy

6 mm
6 mm

163 x 323 cm
160 x 320 cm

Cosmic Silver Parlak 6 mm / Cosmic Silver Glossy 6 mm
Cosmic Silver Parlak 6 mm Rektifiye / Cosmic Silver Glossy 6 mm Rectified

COSMIC SILVER



12 MM

PARLAK / GLOSSY

88000185P | Parlak / Glossy | 12 mm | 83 x 323 cm | Cosmic Silver Parlak 12 mm / Cosmic Silver Glossy 12 mm



NG | STONE
PORCELAIN SLABS

LUTON



12 MM

MAT / MATT

88000085 | Mat / Matt | 12 mm | 163 x 323 cm | Luton Bej Mat 12 mm / Luton Beige Matt 12 mm



12 MM

MAT / MATT

88000174AB | Mat / Matt | 12 mm | 83 x 323 cm | Luton Bej Mat AB 12 mm / Luton Beige Matt AB 12 mm

SAHARA



12 MM

MAT / MATT

88000054	Mat / Matt	12 mm	163 x 323 cm	Sahara Gri Mat 12 mm / Sahara Grey Matt 12 mm
88000054R	Mat / Matt	12 mm	160 x 320 cm	Sahara Gri Mat 12 mm Rektifiye / Sahara Grey Matt 12 mm Rectified



6 MM | **MAT / MATT**

88000055	Mat / Matt	6 mm	163 x 323 cm	Sahara Gri Mat 6 mm / Sahara Grey Matt 6 mm
88000055R	Mat / Matt	6 mm	160 x 320 cm	Sahara Gri Mat 6 mm Rektifiye / Sahara Grey Matt 6 mm Rectified

SAHARA

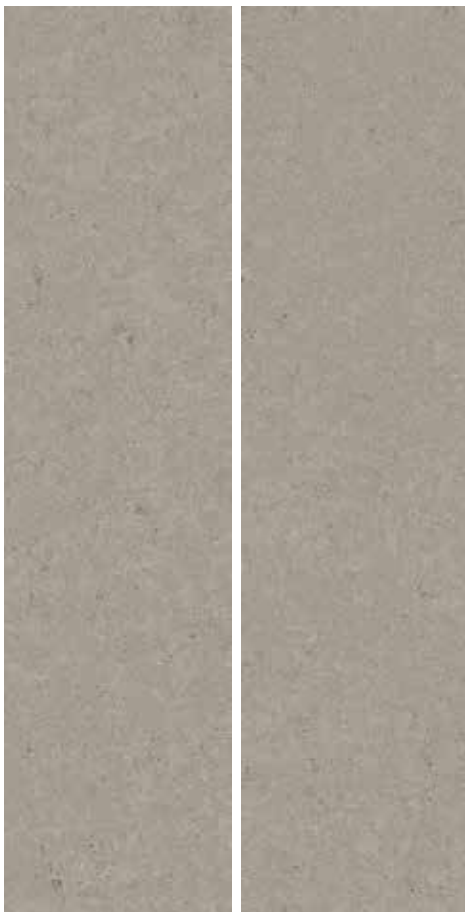

12 MM

MAT / MATT

88000108 | Mat / Matt | 12 mm | 83 x 323 cm | Sahara Gri Mat 12 mm / Sahara Grey Matt 12 mm

NG | STONE
PORCELAIN SLABS

CROSSWOOD



12 MM

MAT / MATT

88000081	Mat / Matt	12 mm	163 x 323 cm	Crosswood Meşe Mat 12 mm / Crosswood Oak Matt 12 mm
88000081R	Mat / Matt	12 mm	160 x 320 cm	Crosswood Meşe Mat 12 mm Rektifiye / Crosswood Oak Matt 12 mm Rectified



6 MM

MAT / MATT

88000082
88000082R

Mat / Matt
Mat / Matt

6 mm
6 mm

163 x 323 cm
160 x 320 cm

Crosswood Meşe Mat 6 mm / Crosswood Oak Matt 6 mm
Crosswood Meşe Mat 6 mm Rektifiye / Crosswood Oak Matt 6 mm Rectified

CROSSWOOD



12 MM

MAT / MATT

88000093 | Mat / Matt | 12 mm | 83 x 323 cm | Crosswood Meşe Mat 12 mm / Crosswood Oak Matt 12 mm

The background of the entire image is a detailed wood-grain pattern, likely oak, with various shades of brown and tan, showing natural wood grain, knots, and textures.

NG | STONE
PORCELAIN SLABS

PALMWOOD





PALMWOOD



12 MM

MAT / MATT

88000083	Mat / Matt	12 mm	163 x 323 cm	Palmwood Natural Mat 12 mm / Palmwood Natural Matt 12 mm
88000083R	Mat / Matt	12 mm	160 x 320 cm	Palmwood Natural Mat 12 mm Rektifiye / Palmwood Natural Matt 12 mm Rectified



6 MM

MAT / MATT

88000084	Mat / Matt	6 mm	163 x 323 cm	Palmwood Natural Mat 6 mm / Palmwood Natural Matt 6 mm
88000084R	Mat / Matt	6 mm	160 x 320 cm	Palmwood Natural Mat 6 mm Rektifiye / Palmwood Natural Matt 6 mm Rectified

PALMWOOD



12 MM

MAT / MATT

88000117 | Mat / Matt | 12 mm | 83 x 323 cm | Palmwood Natural Mat 12 mm / Palmwood Natural Matt 12 mm

OXIDO BROWN





OXIDO BROWN



12 MM

PARLAK / GLOSSY

SATINATO

MAT / MATT

88000040	Mat / Matt	12 mm	163 x 323 cm	Oxido Brown Mat 12 mm / Oxido Brown Matt 12 mm
88000040R	Mat / Matt	12 mm	160 x 320 cm	Oxido Brown Mat 12 mm Rektifiye / Oxido Brown Matt 12 mm Rectified

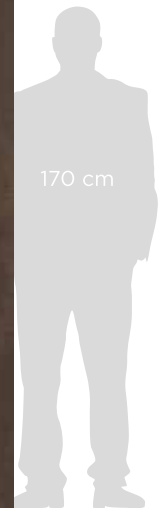

6 MM

MAT / MATT

88000041	Mat / Matt	6 mm	163 x 323 cm	Oxido Brown Mat 6 mm / Oxido Brown Matt 6 mm
88000041R	Mat / Matt	6 mm	160 x 320 cm	Oxido Brown Mat 6 mm Rektifiye / Oxido Brown Matt 6 mm Rectified

OXIDO BROWN



12 MM



MAT / MATT

88000101 | Mat / Matt | 12 mm | 83 x 323 cm | Oxido Brown Mat 12 mm / Oxido Brown Matt 12 mm

NG | STONE
PORCELAIN SLABS

TEKNİK DETAYLAR
TECHNICAL DETAILS

NG KÜTAHYA SERAMİK		SIRLI PORSELEN SERAMİKLERİ TEKNİK ÖZELLİKLERİ (RPN - SATINATO) 163x323 GLAZED PORCELAIN TILES TECHNICAL CHARACTERISTICS (RPN - SATINATO)		
Standartlar Norms	Teknik Özellikler Technical Characteristics	Standart Değerler Required Values	NG Kütahya Seramik Sırlı Ürün Test Değerleri * NG Kütahya Seramik Glazed Product Declared Values *	
EN ISO 10545-2	Boyut ve yüzey kalitesi Dimensions and surface quality	Uzunluk ve genişlik Length and width	± % 0,6 (± 2,0 mm)	± % 0,4
		Kalınlık Thickness	± % 5 (± 0,5 mm)	± % 5 (± 0,5 mm)
		Kenar düzgünlüğü Straightness of sides	± % 0,5 (± 1,5 mm)	± % 0,3
		Gönyeden sapma Rectangularity	± % 0,5 (± 2,0 mm)	± % 0,3
		Merkez - kenar eğriliği - peçlik Centre - edge curvature - warpage	± % 0,5 (± 2,0 mm)	+ % 0,2 / - % 0,1
		Yüzey kalitesi Surface quality	% 95	% 95
EN ISO 10545-3	Su emme % Water absorption %	≤ % 0,5 (her bir karo için max. % 0,6) (individual max. % 0,6)	≤ % 0,3	
EN ISO 10545-4	Kırılma dayanımı (N) Breaking strength (N)	kalınlık ≥ 7,50mm thickness ≥ 7,50mm	min. 1300 N	12 mm ≥ 3500 N 20 mm ≥ 10000 N
		kalınlık < 7,50mm thickness < 7,50mm	min. 700 N	min. 750 N
	Eğilme dayanımı (N/mm ²) Modulus of rupture (N/mm ²)	min. 35 N/mm ²	6 mm ≥ 35 N/mm ² 12 mm ≥ 40 N/mm ² 20 mm ≥ 45 N/mm ²	
EN ISO 10545-5	Siçrama katsayısı, çarpma dayanımı Impact resistance as, coefficient of restitution (cor)	Üretici beyan eder Declared value	Dayanıklıdır Resistant	
EN ISO 10545-7	Aşınma dayanımı Abrasion resistance	Aşınma sınıfı ve devir sayısı beyan edilir Abrasion class and cycles passed	Sınıf 2 - 3 - 4 Class 2 - 3 - 4	
EN ISO 10545-8	Doğrusal ısı genleşme katsayısı (100 °C) Linear thermal expansion	Üretici beyan eder Declared value	6,00 x10 ⁻⁶ - 7,50 x10 ⁻⁶	
EN ISO 10545-9	Isıl şoka dayanıklılık Thermal shock resistance	Dayanıklılık olmalıdır Required	Dayanıklıdır Resistant	
EN ISO 10545-10	Nem genleşmesi Moisture expansion	Üretici beyan eder Declared value	0,01%	
EN ISO 10545-11	Çatlama dayanımı Crazing resistance	Dayanıklılık olmalıdır Required	Dayanıklıdır Resistant	
EN ISO 10545-12	Dona dayanım Frost resistance	Dayanıklılık olmalıdır Required	Dayanıklıdır Resistant	
EN ISO 10545-13	Düşük derişimli asit ve baz Resistance to low concentrations of acids and alkalis	Üretici beyan eder Declared value	LA LA	
	Yüksek derişimli asit ve baz Resistance to high concentrations of acids and alkalis	Üretici beyan eder Declared value	HB HB	
	Ev kimyasalları ve yüzme havuzu tuzları Resistance to household chemicals and swimming pool salts	min. B	A A	
EN ISO 10545-14	Lekelenmeye dayanıklılık Resistance to staining	min. 3.sınıf min. 3.class	min. 3.sınıf min. 3.class	
EN ISO 10545-15	Açığa çıkan tehlikeli maddeler Kurşun - Kadmium Release of dangerous substance Lead - Cadmium	Üretici beyan eder Declared value	Pb < 0,1 Cd < 0,01	
DIN 51130-51097 CEN/TS 16165	Kayganlık (ramp tayini) Slipperiness	Üretici beyan eder Declared value	-	
EN 12004:2007+A1:2012,4,1	Yapışma için bağ gücü Bond strength adhesion	Çimentolu yapıştırıcılar Cementitious adhesives	Üretici beyan eder Declared value	≥ 1,0 Tip C2
EN 12004:2007+A1:2012,4,2		Dağılım yapıştırıcılar Dispersion adhesives	Üretici beyan eder Declared value	
EN 12004:2007+A1:2012,4,3		Reçine reaksiyonlu yapıştırıcılar Reaction resin adhesives	Üretici beyan eder Declared value	
		Harç Mortar	Üretici beyan eder Declared value	
	Yangına tepki Reaction to fire	A1 or A1 _{FL}	A1 or A1 _{FL}	
CEN/TS15209	Dokunurluk Tactility	Yüzey açıklaması beyan edilir Declare surface description	Yüzey açıklaması beyan edilir Declare surface description	
<p>Notlar / Notes</p> <p>* EN 14411 Düşük su emmeli kuru preslenmiş seramik karolar Ek G (Grup BlA) E < %0,5 sırlı (GL)</p> <p>* EN 14411 Dry pressed ceramic tiles with low water absorption Ek G (Grup BlA) E < %0,5 glazed (GL)</p> <p>* Yukarıdaki test sonuçları sadece 1. kalite ürünler için geçerlidir. Aksesuarlar sınıflandırmanın dışında değerlendirilmelidir. Değerler ortalama üretim değerleridir.</p> <p>* The test results refer only to first choice items and they do not regard the trimtiles. The values are based on average production values.</p> <p>* NG Kütahya Seramik bu katalogta yer alan tüm ürünlerin teknik değerlerini değiştirme hakkını saklı tutmaktadır.</p> <p>* NG Kütahya Seramik reserve the right to modify technical and formal details included in this catalog.</p>				

		SIRLI PORSELEN SERAMİKLERİ TEKNİK ÖZELLİKLERİ (MAT-SOFT MAT) 163x323 GLAZED PORCELAIN TILES TECHNICAL CHARACTERISTICS (MATT-SOFT MAT)		
Standartlar Norms	Teknik Özellikler Technical Characteristics		Standart Değerler Required Values	NG Kütahya Seramik Sırlı Ürün Test Değerleri * NG Kütahya Seramik Glazed Product Declared Values *
EN ISO 10545-2	Boyut ve yüzey kalitesi Dimensions and surface quality	Uzunluk ve genişlik Length and width	± % 0,6 (± 2,0 mm)	± % 0,4
		Kalınlık Thickness	± % 5 (± 0,5 mm)	± % 5 (± 0,5 mm)
		Kenar düzgünlüğü Straightness of sides	± % 0,5 (± 1,5 mm)	± % 0,3
		Gönyeden sapma Rectangularity	± % 0,5 (± 2,0 mm)	± % 0,3
		Merkez - kenar eğriliği - peçlik Centre - edge curvature - warpage	± % 0,5 (± 2,0 mm)	+ % 0,2 / - % 0,1
		Yüzey kalitesi Surface quality	% 95	% 95
EN ISO 10545-3	Su emme % Water absorption %		≤ % 0,5 (her bir karo için max. % 0,6) (individual max. % 0,6)	≤ % 0,3
EN ISO 10545-4	Kırılma dayanımı (N) Breaking strength (N)	kalınlık ≥ 7,50mm thickness ≥ 7,50mm	min. 1300 N	12 mm ≥ 3500 N 20 mm ≥ 10000 N
		kalınlık < 7,50mm thickness < 7,50mm	min. 700 N	min. 750 N
	Eğilme dayanımı (N/mm²) Modulus of rupture (N/mm²)		min. 35 N/mm²	6 mm ≥ 35 N/mm² 12 mm ≥ 40 N/mm² 20 mm ≥ 45 N/mm²
EN ISO 10545-5	Sıçrama katsayısı, çarpma dayanımı Impact resistance as, coefficient of restitution (cor)		Üretici beyan eder Declared value	Dayanıklıldır Resistant
EN ISO 10545-7	Aşınma dayanımı Abrasion resistance		Aşınma sınıfı ve devir sayısı beyan edilir Abrasion class and cycles passed	Sınıf 2 - 3 - 4 - 5 Class 2 - 3 - 4 - 5
EN ISO 10545-8	Doğrusal ısıl genişleme katsayısı (100 °C) Linear thermal expansion		Üretici beyan eder Declared value	6,00 x10 ⁻⁶ - 7,50 x10 ⁻⁶
EN ISO 10545-9	Isıl şoka dayanıklılık Thermal shock resistance		Dayanıklı olmalıdır Required	Dayanıklıldır Resistant
EN ISO 10545-10	Nem genişlemesi Moisture expansion		Üretici beyan eder Declared value	0,01%
EN ISO 10545-11	Çatlama dayanımı Crazeing resistance		Dayanıklı olmalıdır Required	Dayanıklıldır Resistant
EN ISO 10545-12	Dona dayanım Frost resistance		Dayanıklı olmalıdır Required	Dayanıklıldır Resistant
EN ISO 10545-13	Düşük derişimli asit ve baz Resistance to low concentrations of acids and alkalis		Üretici beyan eder Declared value	LA LA
	Yüksek derişimli asit ve baz Resistance to high concentrations of acids and alkalis		Üretici beyan eder Declared value	HA HA
	Ev kimyasalları ve yüzme havuzu tuzları Resistance to household chemicals and swimming pool salts		min. B	A A
EN ISO 10545-14	Lekelenmeye dayanıklılık Resistance to staining		min. 3.sınıf min. 3.class	min. 3.sınıf min. 3.class
EN ISO 10545-15	Açığa çıkan tehlikeli maddeler Kurşun - Kadmiyum Release of dangerous substance Lead - Cadmium		Üretici beyan eder Declared value	Pb < 0,1 Cd < 0,01
DIN 51130-5:1097 CEN/TS 16165	Kayganlık (ramp tayini) Slipperiness		Üretici beyan eder Declared value	Sınıf R9 - R10 - R11 - R12 Class R9 - R10 - R11 - R12
EN 12004:2007+A1:2012,4,1	Yapışma için bağ gücü Bond strength adhesion	Çimentolu yapıştırıcılar Cementitious adhesives	Üretici beyan eder Declared value	≥ 1,0 Tip C2
EN 12004:2007+A1:2012,4,2		Dağılım yapıştırıcılar Dispersion adhesives	Üretici beyan eder Declared value	
EN 12004:2007+A1:2012,4,3		Reçine reaksiyonlu yapıştırıcılar Reaction resin adhesives	Üretici beyan eder Declared value	
		Harç Mortar	Üretici beyan eder Declared value	
	Yangına tepki Reaction to fire		A1 or A1 _{FL}	A1 or A1 _{FL}
CEN/TS15209	Dokunurluk Tactility		Yüzey açıklaması beyan edilir Declare surface description	Yüzey açıklaması beyan edilir Declare surface description
Notlar / Notes * EN 14411 Düşük su emmeli kuru preslenmiş seramik karolar Ek G (Grup BlA) E < %0,5 sırlı (GL) * EN 14411 Dry pressed ceramic tiles with low water absorption Ek G (Grup BlA) E < %0,5 glazed (GL) * Yukarıdaki test sonuçları sadece 1. kalite ürünler için geçerlidir. Aksesuarlar sınıflandırmanın dışında değerlendirilmektedir. Değerler ortalama üretim değerleridir. * The test results refer only to first choice items and they do not regard the trimtiles. The values are based on average production values. * NG Kütahya Seramik bu katalogta yer alan tüm ürünlerin teknik değerlerini değiştirme hakkını saklı tutmaktadır. * NG Kütahya Seramik reserve the right to modify technical and formal details included in this catalog.				

NG KÜTAHYA SERAMİK		SIRLI PORSELEN SERAMİKLERİ TEKNİK ÖZELLİKLERİ (RPN - SATINATO) 160x320 REKT. GLAZED PORCELAIN TILES TECHNICAL CHARACTERISTICS (RPN - SATINATO)		
Standartlar Norms	Teknik Özellikler Technical Characteristics	Standart Değerler Required Values	NG Kütahya Seramik Sırlı Ürün Test Değerleri * NG Kütahya Seramik Glazed Product Declared Values *	
EN ISO 10545-2	Boyut ve yüzey kalitesi Dimensions and surface quality	Uzunluk ve genişlik Length and width	± % 0,6 (± 2,0 mm)	± % 0,15
		Kalınlık Thickness	± % 5 (± 0,5 mm)	± % 5 (± 0,5 mm)
		Kenar düzgünlüğü Straightness of sides	± % 0,5 (± 1,5 mm)	± % 0,3
		Gönyeden sapma Rectangularity	± % 0,5 (± 2,0 mm)	± % 0,3
		Merkez - kenar eğriliği - peçlik Centre - edge curvature - warpage	± % 0,5 (± 2,0 mm)	+ % 0,2 / - % 0,1
		Yüzey kalitesi Surface quality	% 95	% 95
EN ISO 10545-3	Su emme % Water absorption %	≤ % 0,5 (her bir karo için max. % 0,6) (individual max. % 0,6)	≤ % 0,3	
EN ISO 10545-4	Kırılma dayanımı (N) Breaking strength (N)	kalınlık ≥ 7,50mm thickness ≥ 7,50mm	min. 1300 N	12 mm ≥ 3500 N 20 mm ≥ 10000 N
		kalınlık < 7,50mm thickness < 7,50mm	min. 700 N	min. 750 N
	Eğilme dayanımı (N/mm ²) Modulus of rupture (N/mm ²)	min. 35 N/mm ²	6 mm ≥ 35 N/mm ² 12 mm ≥ 40 N/mm ² 20 mm ≥ 45 N/mm ²	
EN ISO 10545-5	Siçrama katsayısı, çarpma dayanımı Impact resistance as, coefficient of restitution (cor)	Üretici beyan eder Declared value	Dayanıklıldır Resistant	
EN ISO 10545-7	Aşınma dayanımı Abrasion resistance	Aşınma sınıfı ve devir sayısı beyan edilir Abrasion class and cycles passed	Sınıf 2 - 3 - 4 Class 2 - 3 - 4	
EN ISO 10545-8	Doğrusal ısıl genişleme katsayısı (100 °C) Linear thermal expansion	Üretici beyan eder Declared value	6,00 x10 ⁻⁶ - 7,50 x10 ⁻⁶	
EN ISO 10545-9	Isıl şoka dayanıklılık Thermal shock resistance	Dayanıklılmalıdır Required	Dayanıklıldır Resistant	
EN ISO 10545-10	Nem genişmesi Moisture expansion	Üretici beyan eder Declared value	0,01%	
EN ISO 10545-11	Çatlama dayanımı Crazing resistance	Dayanıklılmalıdır Required	Dayanıklıldır Resistant	
EN ISO 10545-12	Dona dayanım Frost resistance	Dayanıklılmalıdır Required	Dayanıklıldır Resistant	
EN ISO 10545-13	Düşük derişimli asit ve baz Resistance to low concentrations of acids and alkalis	Üretici beyan eder Declared value	LA LA	
	Yüksek derişimli asit ve baz Resistance to high concentrations of acids and alkalis	Üretici beyan eder Declared value	HB HB	
	Ev kimyasalları ve yüzme havuzu tuzları Resistance to household chemicals and swimming pool salts	min. B	A A	
EN ISO 10545-14	Lekelenmeye dayanıklılık Resistance to staining	min. 3.sınıf min. 3.class	min. 3.sınıf min. 3.class	
EN ISO 10545-15	Açığa çıkan tehlikeli maddeler Kurşun - Kadmium Release of dangerous substance Lead - Cadmium	Üretici beyan eder Declared value	Pb < 0,1 Cd < 0,01	
DIN 51130-51097 CEN/TS 16165	Kayganlık (ramp tayini) Slipperiness	Üretici beyan eder Declared value	-	
EN 12004:2007+A1:2012,4,1	Yapışma için bağ gücü Bond strength adhesion	Çimentolu yapıştırıcılar Cementitious adhesives	Üretici beyan eder Declared value	≥ 1,0 Tip C2
EN 12004:2007+A1:2012,4,2		Dağılım yapıştırıcılar Dispersion adhesives	Üretici beyan eder Declared value	
EN 12004:2007+A1:2012,4,3		Reçine reaksiyonlu yapıştırıcılar Reaction resin adhesives	Üretici beyan eder Declared value	
		Harç Mortar	Üretici beyan eder Declared value	
	Yangına tepki Reaction to fire	A1 or A1 _{FL}	A1 or A1 _{FL}	
CEN/TS15209	Dokunurluk Tactility	Yüzey açıklaması beyan edilir Declare surface description	Yüzey açıklaması beyan edilir Declare surface description	
<p>Notlar / Notes</p> <p>* EN 14411 Düşük su emmeli kuru preslenmiş seramik karolar Ek G (Grup BlA) E < %0,5 sırlı (GL)</p> <p>* EN 14411 Dry pressed ceramic tiles with low water absorption Ek G (Grup BlA) E < %0,5 glazed (GL)</p> <p>* Yukarıdaki test sonuçları sadece 1. kalite ürünler için geçerlidir. Aksesuarlar sınıflandırmanın dışında değerlendirilmektedir. Değerler ortalama üretim değerleridir.</p> <p>* The test results refer only to first choice items and they do not regard the trimtiles. The values are based on average production values.</p> <p>* NG Kütahya Seramik bu katalogta yer alan tüm ürünlerin teknik değerlerini değiştirme hakkını saklı tutmaktadır.</p> <p>* NG Kütahya Seramik reserve the right to modify technical and formal details included in this catalog.</p>				

NG KÜTAHYA SERAMİK		SIRLI PORSELEN SERAMİKLERİ TEKNİK ÖZELLİKLERİ (MAT-SOFT MAT) 160x320 REKT. GLAZED PORCELAIN TILES TECHNICAL CHARACTERISTICS (MATT-SOFT MAT)		
Standartlar Norms	Teknik Özellikler Technical Characteristics	Standart Değerler Required Values	NG Kütahya Seramik Sırlı Ürün Test Değerleri * NG Kütahya Seramik Glazed Product Declared Values *	
EN ISO 10545-2	Boyut ve yüzey kalitesi Dimensions and surface quality	Uzunluk ve genişlik Length and width	± % 0,6 (± 2,0 mm)	± % 0,15
		Kalınlık Thickness	± % 5 (± 0,5 mm)	± % 5 (± 0,5 mm)
		Kenar düzgünlüğü Straightness of sides	± % 0,5 (± 1,5 mm)	± % 0,3
		Gönyeden sapma Rectangularity	± % 0,5 (± 2,0 mm)	± % 0,3
		Merkez - kenar eğriliği - peçlik Centre - edge curvature - warpage	± % 0,5 (± 2,0 mm)	+ % 0,2 / - % 0,1
		Yüzey kalitesi Surface quality	% 95	% 95
EN ISO 10545-3	Su emme % Water absorption %	≤ % 0,5 (her bir karo için max. % 0,6) (individual max. % 0,6)	≤ % 0,3	
EN ISO 10545-4	Kırılma dayanımı (N) Breaking strength (N)	kalınlık ≥ 7,50mm thickness ≥ 7,50mm	min. 1300 N	12 mm ≥ 3500 N 20 mm ≥ 10000 N
		kalınlık < 7,50mm thickness < 7,50mm	min. 700 N	min. 750 N
	Eğilme dayanımı (N/mm ²) Modulus of rupture (N/mm ²)	min. 35 N/mm ²	6 mm ≥ 35 N/mm ² 12 mm ≥ 40 N/mm ² 20 mm ≥ 45 N/mm ²	
EN ISO 10545-5	Sıçrama katsayısı, çarpma dayanımı Impact resistance as, coefficient of restitution (cor)	Üretici beyan eder Declared value	Dayanıklıldır Resistant	
EN ISO 10545-7	Aşınma dayanımı Abrasion resistance	Aşınma sınıfı ve devir sayısı beyan edilir Abrasion class and cycles passed	Sınıf 2 - 3 - 4 - 5 Class 2 - 3 - 4 - 5	
EN ISO 10545-8	Doğrusal ısı genleşme katsayısı (100 °C) Linear thermal expansion	Üretici beyan eder Declared value	6,00 x10 ⁻⁶ - 7,50 x10 ⁻⁶	
EN ISO 10545-9	Isıl şoka dayanıklılık Thermal shock resistance	Dayanıklılmalıdır Required	Dayanıklıldır Resistant	
EN ISO 10545-10	Nem genişmesi Moisture expansion	Üretici beyan eder Declared value	0,01%	
EN ISO 10545-11	Çatlama dayanımı Crazing resistance	Dayanıklılmalıdır Required	Dayanıklıldır Resistant	
EN ISO 10545-12	Dona dayanım Frost resistance	Dayanıklılmalıdır Required	Dayanıklıldır Resistant	
EN ISO 10545-13	Düşük derişimli asit ve baz Resistance to low concentrations of acids and alkalis	Üretici beyan eder Declared value	LA LA	
	Yüksek derişimli asit ve baz Resistance to high concentrations of acids and alkalis	Üretici beyan eder Declared value	HA HA	
	Ev kimyasalları ve yüzme havuzu tuzları Resistance to household chemicals and swimming pool salts	min. B	A A	
EN ISO 10545-14	Lekelenmeye dayanıklılık Resistance to staining	min. 3.sınıf min. 3.class	min. 3.sınıf min. 3.class	
EN ISO 10545-15	Açığa çıkan tehlikeli maddeler Kurşun - Kadmiyum Release of dangerous substance Lead - Cadmium	Üretici beyan eder Declared value	Pb < 0,1 Cd < 0,01	
DIN 51130-5:1097 CEN/TS 16165	Kayganlık (ramp tayini) Slipperiness	Üretici beyan eder Declared value	Sınıf R9 - R10 - R11 - R12 Class R9 - R10 - R11 - R12	
EN 12004:2007+A1:2012,4,1	Yapışma için bağ gücü Bond strength adhesion	Çimentolu yapıştırıcılar Cementitious adhesives	Üretici beyan eder Declared value	≥ 1,0 Tip C2
EN 12004:2007+A1:2012,4,2		Dağılım yapıştırıcılar Dispersion adhesives	Üretici beyan eder Declared value	
EN 12004:2007+A1:2012,4,3		Reçine reaksiyonlu yapıştırıcılar Reaction resin adhesives	Üretici beyan eder Declared value	
		Harç Mortar	Üretici beyan eder Declared value	
	Yangına tepki Reaction to fire	A1 or A1 _{FL}	A1 or A1 _{FL}	
CEN/TS15209	Dokunurluk Tactility	Yüzey açıklaması beyan edilir Declare surface description	Yüzey açıklaması beyan edilir Declare surface description	
<p>Notlar / Notes</p> <p>* EN 14411 Düşük su emmeli kuru preslenmiş seramik karolar Ek G (Grup Bla) E < %0,5 sırlı (GL)</p> <p>* EN 14411 Dry pressed ceramic tiles with low water absorption Ek G (Grup Bla) E < %0,5 glazed (GL)</p> <p>* Yukarıdaki test sonuçları sadece 1. kalite ürünler için geçerlidir. Aksesuarlar sınıflandırmanın dışında değerlendirilmektedir. Değerler ortalama üretim değerleridir.</p> <p>* The test results refer only to first choice items and they do not regard the trimtiles. The values are based on average production values.</p> <p>* NG Kütahya Seramik bu katalogta yer alan tüm ürünlerin teknik değerlerini değiştirme hakkını saklı tutmaktadır.</p> <p>* NG Kütahya Seramik reserve the right to modify technical and formal details included in this catalog.</p>				

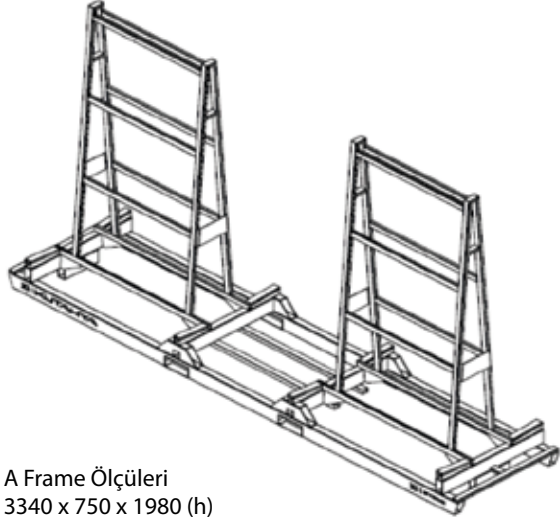

A Frame Ölçüleri
3340 x 750 x 1980 (h)

NG STONE TIR YÜKLEME BİLGİLERİ

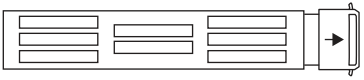
Metal A Frame 12 mm	Levha Kalınlık	Levha Yüzeı	Toplam A Frame Adeti	A Frame Levha Adeti	Toplam Levha Adeti	Toplam m ²	Kg / Levha	Kg / A Frame (A Frame dahil)	Tır Yükleme Toplam Ağırlığı (A Frame dahil)
	12 mm	Mat Satinato Parlak	8	20	160	819	149	3.100	24.800

A framelerin araçtan indirilmesi esnasında minimum 5 tonluk forklift kullanılmalıdır. Dikkat edilmesi önem arz etmektedir.

